



csem



BKW



Schweizerische Eidgenossenschaft
Confédération suisse
Confederazione Svizzera
Confederaziun svizra

Bundesamt für Energie BFE
Swiss Federal Office of Energy SFOE



Focus report: Distribution Grid Integration

Prosumer-Lab

Author: Lukas Heiniger (BTH-TI)
Co-Authors: Michael Höckel (BFH-TI),
Steffen Wienands (BFH-TI),
Michel Arnal (BKW)

BFE-program manager: Dr. Michael Moser
BFE-project number: SI/501434

Version 1.0 / 26.11.2019

Abstract

The LEN group (Power Grids Lab, Bern University of Applied Sciences) analyzes the effect of an energy management system (EMS) on the grid stability. In collaboration with BKW, the distribution grid of Schüpfenried has been chosen as platform for modelling and simulation. Based on the grid data provided by BKW, the simulation model has been built using the power system analysis software PowerFactory from DlgSILENT. The simplified algorithms of several EMS were implemented in PowerFactory to simulate the effect of an EMS on the grid stability in terms of voltage and loading, and how those EMS can improve the overall grid stability. The simulations have shown that the rise of the voltage due to the PV power can be damped by almost 6 % with help of the EMS (compared to the situation without EMS). Furthermore, the influences of decentralized feed-in on the power quality has been investigated based on measurements carried out on the Prosumer-Lab testbench.

Table of contents

1	Summary	4
2	Introduction	9
3	RQ-3002a: Impact of EMSs on the grid stability	10
4	RQ-3002b: EMS with information about weather forecasts	14
5	RQ-3002c: Strategies to stabilize the grid	17
6	RQ-3003: Quantified potential of EMSs to stabilize the grid	22
7	RQ-3004: Impact on the grid stability in case of a malfunction of the EMSs	25
8	RQ-3005: PV growth according to «Energierstrategie 2050»,	27
9	RQ-3006: Impact of the decentralized energy production on the power quality	32
10	Conclusion	36
11	Outlook	37
12	List of Figures	38
13	Glossary	39
14	References	40
15	Appendix	41
16	Version control	48

1 Summary

From the point of view of the distribution grid, what are the requirements of smart energy management systems in buildings to guarantee or even improve grid stability?

Stabilization of the low voltage grid has increasingly become a challenge for the distribution system operators (DSO) due to the considerable increase in the number of prosumers. Nowadays many of those prosumers are not just feeding the energy of their PV system back into the grid, but rather trying to increase their self-consumption rate. Thus, up to a certain level, they become independent from the grid. To achieve this, the prosumer needs a storage system in combination with an intelligent energy management system (EMS). The focus question of this report is to identify in which ways these EMS can contribute to maintain or improve the stability of the grid and under which requirements this can be achieved. The term “grid stability” in this context refers to a grid where no lines are overloaded, and the voltage does not exceed the limits of +10%/-15% of the nominal voltage (required by the EN50160). To answer this focus question, together with BKW the low voltage grid of Schüpfenried was chosen as a basis for a simulation model, using the power system analysis software PowerFactory from DigSILENT. For the simulations, a part of the grid of Schüpfenried, consisting of ten customers, was considered. This section of the grid is connected via an overhead line to the transformer station. The end customers are predominantly single-family households and farms, which offer large rooftop areas for potential PV systems. The load profiles of the customers used for the simulations were generated by the load-profile generator of Noah Pflugradt [1]. Due to privacy concerns, the measured load profiles were not available and therefore could not be used. Based on the annual consumption, which results from the synthetic load profiles, a potential PV and battery storage system for those ten customers was dimensioned according to the rule of thumb (1 MWh consumption per year = 1 kW nominal PV power = 1 kWh storage capacity). The PV profiles are based on a measurement of a 660-kW_p-PV-system in Thun from October 2018 and are scaled accordingly. Therefore it is important to mention that the obtained result could slightly change if the PV profiles would be based on a measurement of another season of the year. The mounting angle and orientation of the PV-system were not considered. Furthermore, a simulation model of an EMS has been implemented for all the customers in the simulation model of Schüpfenried. Unlike the EMS developed by CSEM, which is controlling the heatpump, this EMS considers only the control of a battery storage system. It has been implemented in such a way that it allows a power-controlled and a voltage-controlled mode. Power-controlled means that the charging or discharging power of the battery is defined by the difference in the power of the PV system and the load. If this value exceeds a given upper or lower threshold (in this document referred to as dead band), the battery system is either charged or discharged. Voltage-controlled mode on the other hand means that the charging- or discharging-power of the battery is defined by the voltage at its connection point. To answer the focus question several scenarios are compared:

Scenario	Description
1	No one has installed a battery storage system with EMS.
2	Everyone has a battery storage system with EMS in power-controlled mode with a dead band of ± 1 kW
3	Everyone has a battery storage system with EMS in power-controlled mode with an upper dead band of $\frac{1}{2}$ the nominal PV power and a lower dead band of $- 1$ kW.
4	Same as Scenario 3 but with doubled storage capacity
5	Everyone has a battery storage system with EMS in voltage-controlled mode

The simulations have shown that if all the PV systems are being operated without EMS and battery storage, the maximal voltage in the grid increases by 7% over the nominal value. If the PV systems are operated in combination with a storage unit and an EMS with a dead band of ± 1 kW, the first part of the voltage increase can be intercepted by charging the storage with the excess PV power. In the afternoon, however, the storages are fully charged under this configuration, which forces the EMS to feed the PV power back into the grid, which then results in a strong increase of the voltage. The loading of the overhead line shows a very similar behavior. In the early afternoon, when most of the storages are fully charged, the loading increases up to 35%. To counteract this, it would be reasonable to adjust the power

dead band of the EMS depending on the weather to store just the peak power of the PV systems. Therefore, for the next simulation the upper dead band of all of the EMS is set to 50% of the nominal installed PV power. This means that on a sunny day the EMS waits longer before it starts to store the PV energy. This allows the EMS to store the peak power of the PV system (peak shaving) and thus reducing the high peak voltage in the afternoon. As the simulations have shown, the situation can be further improved if in addition the battery storage capacity is doubled. Another solution would be to further increase the dead band (Figure 1). The power-controlled EMS are primarily orientated in increasing the self-consumption rate of the customers rather than stabilizing the grid.

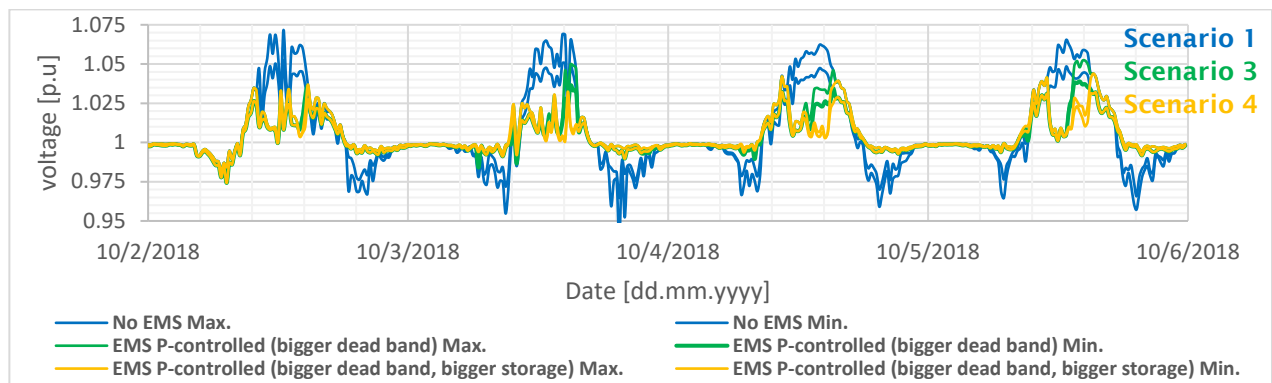

Figure 1: Envelope of the voltages of all simulated grid points when all the EMSs are operating in power-controlled mode

In the next scenario, the behavior of a voltage-controlled EMS is investigated. The main goal of a voltage-controlled EMS is not to increase the self-consumption rate of the customer, but to increase the grid stability. It is therefore more interesting for the DSO rather than the customer. The voltage-controlled EMS sets the charge or discharge power of the battery storage depending on how much the voltage at the connection point is outside the dead band limit. If the EMS would just set a constant charge or discharge power whenever the voltage is outside of the dead band, the system would start to oscillate. For this reason, the EMS must have a droop assigned. The droop determines how sensitive the EMS sets the battery storage power, depending on a specific voltage change.

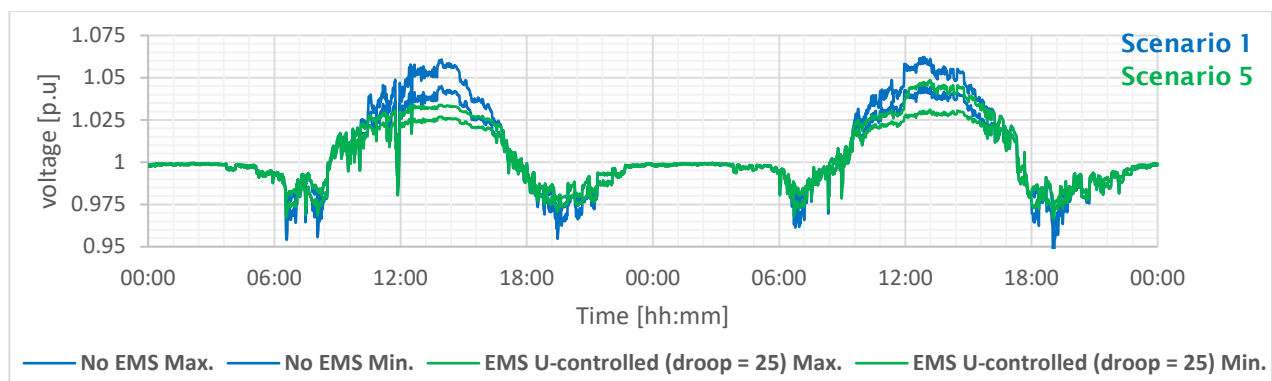

Figure 2: Envelope of the voltages of all simulated grid points when all the EMSs are operating in voltage-controlled mode

As can be seen in Figure 2, in this case the maximum voltage can be reduced by up to 3%. The voltage increase during the day caused by the PV power is smoothly cut off in this operating mode. The optimal droop for each voltage-controlled EMS in the grid depends on the maximal and minimal voltage at its connection point and must be defined for each EMS individually. To determine the optimum droop value, a simulation was first carried out with all the EMSs deactivated. Then the obtained maximum voltage was set as reference for the parameterization.

To quantify all the simulation results in terms of the potential to stabilize the grid, the following procedure was chosen. The situation where no customers have an EMS was defined as a reference scenario. Then the difference in percent between the voltage occurring in the reference scenario and the voltage occurring during the various configurations of the EMS is calculated. As shown in Figure 3,

the rise of the voltage due to the PV power can be damped by almost 6% with help of the EMSs. The problem with the configuration of the power-controlled EMS with a dead band of ± 1 kW is that the voltage can be stabilized only in the first half of the day. After that, all the battery storages in the grid are mostly fully charged and the potential to stabilize the grid decreases to zero (red curve in Figure 3). The increase of the dead band as soon as the weather forecast predicts sunny weather results in a longer period of the day where the voltage can be reduced with the EMSs (green and yellow curve in Figure 3). It can be seen that the power-controlled EMSs are in general more effective than the voltage-controlled EMSs. This is due to the fact, that the stabilization potential of the voltage-controlled EMS is connected to its droop value, which determines how sensitive the charging power of the battery storage is set, according to a certain change in the voltage. The simulations were done for a period of four days, however Figure 3 just shows one single day.

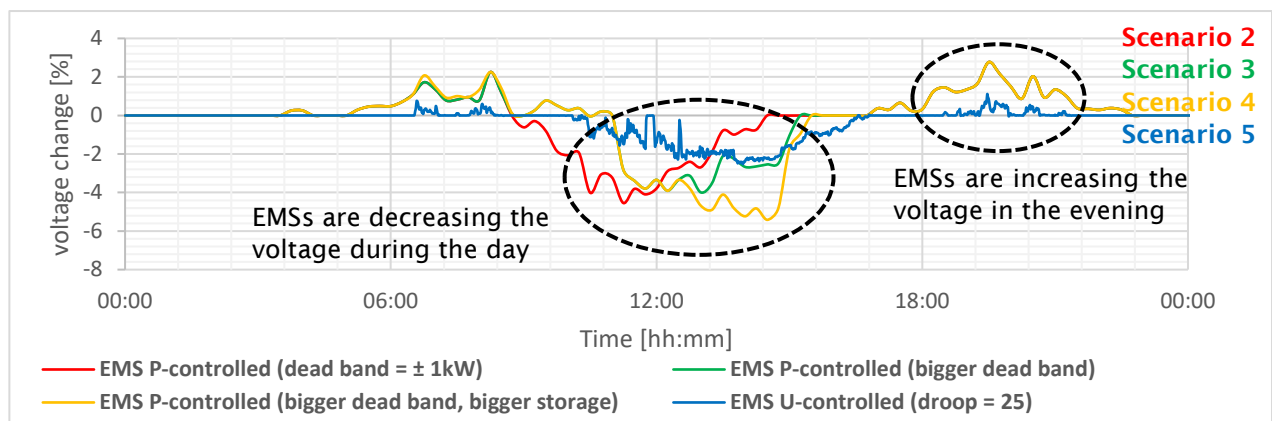

Figure 3: Change of voltage in percent between the reference scenario and the various configuration of the EMS

To conclude, in the terms of grid stabilization the power-controlled EMSs seem to be more effective than voltage-controlled EMSs, but only for the ones with a bigger dead band (Scenario 3 and 4). It is important to add, that this is not a general statement. In Scenario 3 and 4, the power-controller EMS are more effective compared to the voltage-controlled EMS. But this is only because of the fact, that the EMS and the storage are parametrized accordingly, in order to store the complete peak of the PV power. Therefore, they are able to damp the voltage increase more efficiently than the voltage-controlled EMS. In Scenario 2 on the other, the power-controlled EMS with the dead band of ± 1 kW won't decrease the voltage throughout the whole day, since the storage is fully charged around noon and the PV power is fed into the grid. From point of view of the DSO this configuration is therefore not desirable. The most efficient configuration in this particular simulation would be to run the EMS in power-controlled mode with an increased dead band and a bigger storage (Scenario 4). This configuration allows the EMS to cut the complete peak of the PV-power and therefore reduce the voltage increase in a most efficient way.

To conclude, if the power-controlled EMS and the storage are dimensioned in a way that they are able to store the peak of the PV power, they can be more efficient than the voltage-controlled EMS in terms of grid stabilization. However, the voltage-controlled EMS will still be a more reliable solution, since it charges the battery depending on the voltage, whereas the power-controlled EMS does not consider the voltage. The voltage-controlled EMS however has the downside that the utilization of the storage might not be optimal. Meaning, the EMS will charge the battery only if the voltage reaches a critical level, while during the rest of the time, the storage is not used.

To answer the focus question: in order to guarantee or even improve grid stability, an EMS must fulfill the following conditions:

- The dead band (i.e. threshold) at which the EMS starts to charge the battery storage must be set high enough in order to store the peak of the PV power (at least 50% of the nominal PV power).
- Storage must be dimensioned big enough (at least 1 kWh capacity for each kW_p PV power).
- Regarding the voltage-controlled EMS: A correct parameterization is crucial.

To give a more general statement: To improve the grid stability, it is important to store the peak of the PV power. However, the ideal value for the dead band is strongly correlating to the storage capacity. In other words, the lower the dead band the bigger the storage must be in order to store the peak of the PV power and vice versa. Therefore, depending on the dead band value and the storage capacity the power-controlled mode of the EMS is a mix between self-consumption and improvement of the grid stability, while the voltage-controlled mode is generally just focused on improving the grid-stability. Furthermore, it could be shown that the load flow in the overhead line in the morning and evening is significantly higher when all the EMSs are in voltage-controlled mode (Scenario 5) compared to scenario 2, where the EMSs are in power-controlled mode with a dead band of ± 1 kW (Figure 4). This is because scenario 2 is focused only on the improvement of the self-consumption. In other words, the main goal of those EMSs is to store as much PV power as possible and use all the stored power later in the evening. Compared to the situation without EMS (Scenario 1), the load flow, i.e. the consumption from the grid, can be reduced in the evening by up to 20 kW with the power-controlled EMS. That means all the customers are using the power from their own storages. While with the voltage-controlled EMS the load flow can only be reduced by around 6 kW (black mark in Figure 4). Therefore the customers still have to buy energy from the grid in order to cover their consumption. This shows that the improvement of the grid stability and the increasing of self-consumption are rather conflicting goals.

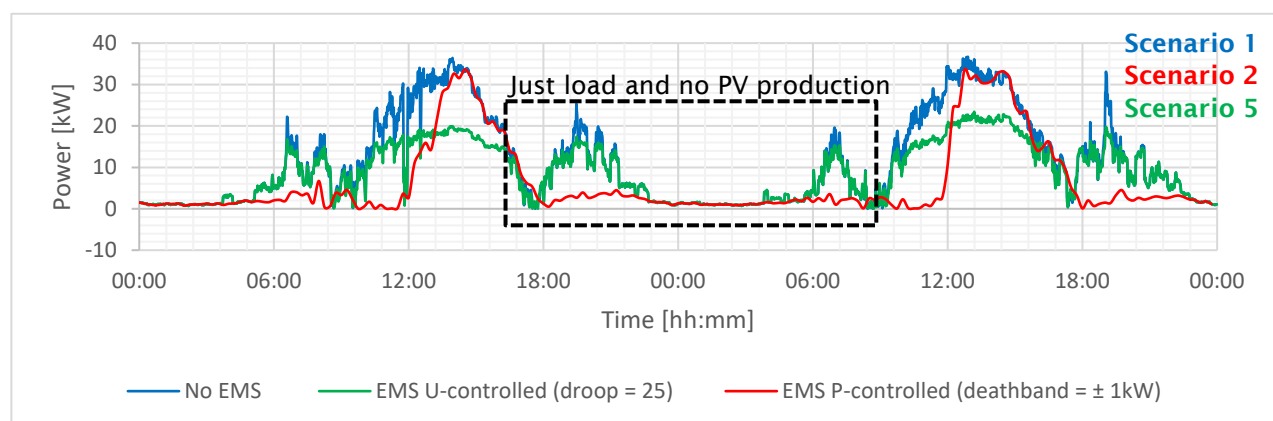

Figure 4: Power flow in the overhead line when all the EMS are operating either in voltage-controlled mode or in power-controlled mode

Furthermore, the situation regarding the PV growth predicted by the «Energierstrategie 2050» has been investigated. The most extreme scenario of the «Energierstrategie 2050» requires a total of 11 TWh energy per year produced by PV systems. This leads to the conclusion that a total of 45% of the available roof space of every house in Switzerland needs to be covered by a PV system. In the analyzed part of the Schüpfenried grid a lot of the houses are farmhouses with very large roofs. In such a case an EMS controlled storage-system for every single household would be obsolete, since the consumption of the house is very small compared to the resulting PV production. As the simulation has shown, the increase of the voltage during a sunny day, as well as the loading of the overhead line in such a case, would be severe. The voltage would increase up to 1.2 p.u, which is a clear violation of the given limit of +10% required by the EN50160, and the overhead line would reach a loading of about 170% and could thus not be operated any longer. In this scenario a central storage combined with a central EMS has proven itself a good solution, in order to keep the voltage and line loading in an acceptable range. Since in terms of loading, the main supply line, i.e. the overhead line, is the most critical point in this grid, it is best to place the central storage at the end of the overhead line.

This simulation considers only the technical aspect of the central storage. The economic aspects were not part of the study. From an economically point of view a central storage might not be the most efficient solution. Furthermore, the investigated grid was a very rural area, with buildings with large roofs, which leads to a high PV power according to the Energierstrategie 2050. The same simulation in an urban area with buildings with smaller roofs would probably lead to a different conclusion. In an urban area it might be more efficient to install multiple small decentral storages in every house rather than one big central storage in the transformer station.

Furthermore, the implemented EMS model of the power-controlled EMS has been verified using the Prosumer-Lab and a Varta battery system, which includes its own power-controlled EMS. The simulated power-profile of the battery shows a difference of max. 10% compared to the measured one. However, since the whole simulation is based on synthetic load profiles instead of measurements, the results of the simulations can only answer the focus question in a qualitative way, rather than quantitative. Nonetheless, the obtained results give a good impression of the potential to stabilize the grid, which is possible with an EMS. However, it is important to mention that these simulations are based on the specific grid of Schüpfenried, which is very a rural grid. The effect of an EMS on the grid stability however can change, depending on the grid topology, as well as the load profiles of the customers in the grid. For example in a urban grid it would be expected that the voltage changes due to PV power would be less significant, since the lines are in general shorter and the short circuit power is higher. Therefore the effect of an EMS would also be less significant. It is therefore strongly recommended that before the DSO relies on EMSs as a solution to maintain or improve grid stability, a simulation for the particular grid should be carried out.

Furthermore, it is important to add, that the simulations were all done on a quasi-dynamic basis. This means the simulation consists of a series of discrete independent timesteps. Therefore, the variables in the quasi-dynamic simulations are independent of time. In a dynamic simulation on the other hand, all the variables, e.g. the voltages, are time-dependent. Meaning the simulations are done in a continuous way, which could lead to a slightly different behavior of the EMS. For example, if the droop-value for the voltage-controlled EMS was chosen too high, the quasi-dynamic simulation would show a oscillating behavior of the EMS. This is however only because the quasi-dynamic simulation considers only discrete independent timesteps, which does not represent reality. In a dynamic simulation this system would not oscillate. Therefore, to further analyze the subject of the voltage-controlled EMS, it is recommended to also consider using a dynamic simulation.

2 Introduction

Stabilization of the low voltage grid has increasingly become a challenge for the distribution system operators (DSO) due to the considerable increase in the number of prosumers. Nowadays many of those prosumers are not just feeding the energy of their PV system back into the grid, but rather trying to increase their self-consumption rate and becoming, up to a certain degree, independent of the grid. Therefore, the prosumer needs a storage system in combination with an intelligent energy management system (EMS). There are many different types of EMS available on the market. In general it is known, how a single EMS influences the load profiles of the customer. However, the impact of a combination of several prosumers with installed EMSs on the grid is not obvious. The primary purpose of an EMS is to increase the self-consumption of the PV power for the prosumer. But, since it is expected that in the near future the number of prosumers will increase, it is of interest how those EMSs could also be used to improve the stability of the grid, which leads to the main focus question of this report:

From the point of view of the distribution grid, what are the requirements of smart energy management systems in buildings to guarantee or even improve grid stability?

The focus question of this report aims to identify in which way those EMSs can contribute to maintain or improve the stability of the grid. Furthermore, it is of interest under what requirements and constraints this objective can be achieved. The term “grid stability” in this context refers to a grid where no lines are overloaded, and the voltage does not exceed the limits of +10%/-15% of the nominal voltage (required by the EN50160).

To answer this focus question in reasonable depth, several research questions have been introduced. These research-questions and the corresponding results are explained in the following chapters. Figure 5 shows the research fields dealt with in this report and how those are connected to the research questions in other subject areas

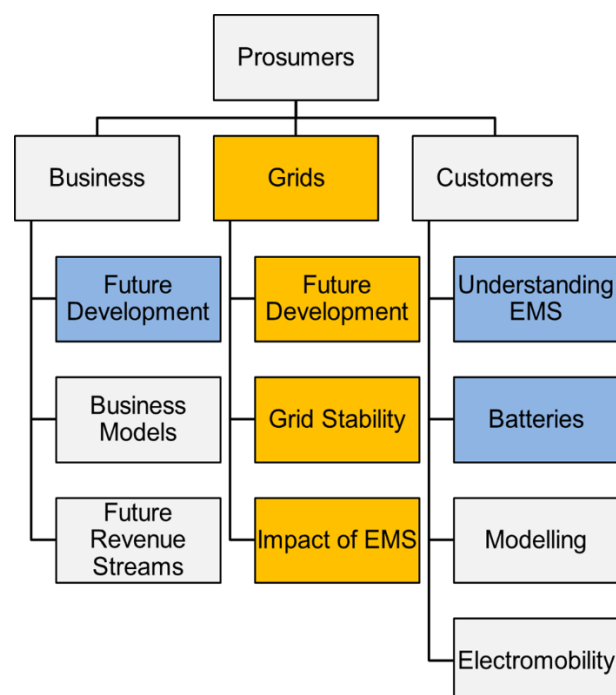

Figure 5: Research fields dealt with in this report are highlighted in orange, inputs from research questions in other subject areas are highlighted in blue

3 RQ-3002a: Impact of EMSs on the grid stability

How does the impact of a PV system on the grid stability look like when using a storage system combined with an EMS?

3.1 Summary

Using a simulation model, which is based on the grid data of a low-voltage grid in Schüpfenried, the effect of an EMS on the grid stability, in terms of voltage and line loading, has been investigated. Two scenarios were considered. On the one hand, the situation where every customer has a PV system installed, but no one is interested in installing an EMS and storage system. And, on the other hand, the scenario when, in addition to the PV system, every customer has installed an EMS and a battery storage system. The EMSs are set in power-controlled mode. Which means that the charging or discharging power of the storage is defined by the difference in the power of the PV system and the load. As far as the simulation has shown, the increase of the voltage due to the PV systems can be intercepted, by charging the storage with the excess of PV power. In the afternoon, however, the storages are usually fully charged, and the voltage increases rapidly. The same applies to the line loading. This leads to the conclusion that this method is a good solution for the customer in order to use all the energy produced by the PV system, but rather a bad solution for the DSO in terms of grid stability.

3.2 Method

Together with BKW, the Schüpfenried low-voltage grid was chosen as a basis for a simulation model. For the following simulations, only a remote part of the grid of Schüpfenried, consisting of ten customers, was considered. This part of the grid is connected via an overhead line to the transformer station. The end customers are predominantly single-family homes and farms (Figure 6).

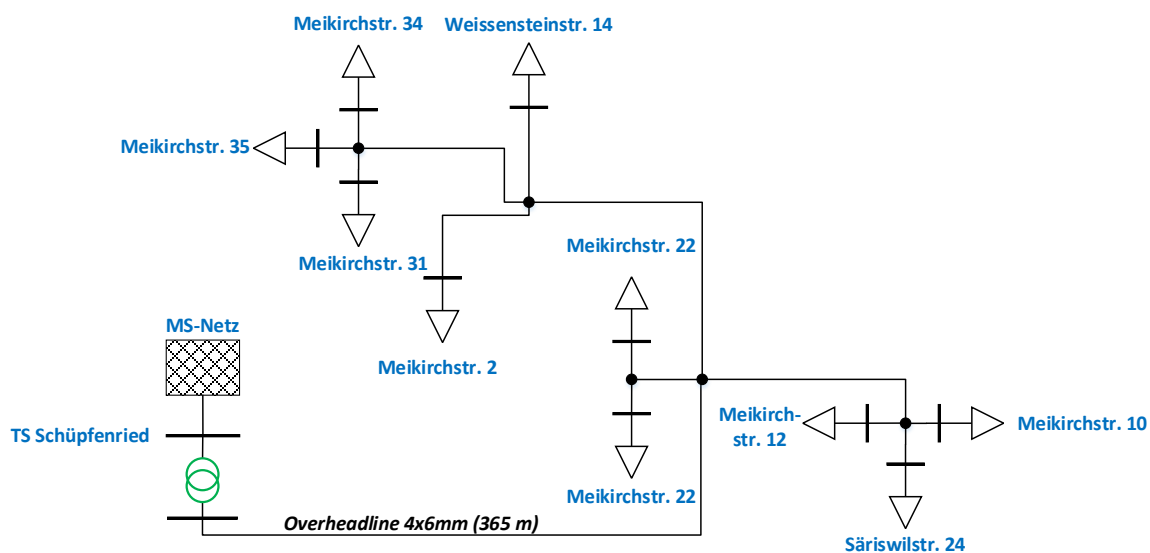

Figure 6: Scheme of the analyzed part of the low voltage grid of Schüpfenried

3.2.1 Load and PV profiles of the customers

The load profiles of the customers, used for the simulations, are generated by the Load Profile Generator of Noah Pflugradt, because, due to privacy concerns, the measured load-profiles were not available [1]. Those profiles were generated for a period of one year in a resolution of one minute. The PV profiles are based on a measurement of a 660-kW_p-PV-system in Thun from October 2018 and are scaled accordingly. Therefore it is important to mention that the obtained result could slightly change if the PV profiles would be based on a measurement of July. The mounting angle and orientation of the PV-system were not considered.

The profiles are listed in appendix 15.3.

3.2.2 Dimensioning of the PV and storage systems

Based on the annual consumption, possible PV and storage systems are dimensioned for the customers in the analyzed grid according to the rule of thumb in Figure 7.

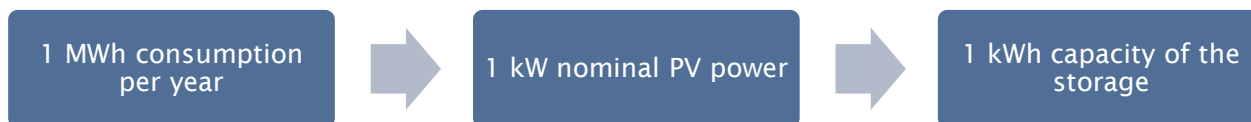

Figure 7: Rule of thumb for the dimensioning of the PV and battery storage systems

For the simulations, the specifications of the storage system «LG Chem RESU10H» are used (Figure 8).

specifications of «LG Chem»	
Nominal capacity [kWh]	9.3
nominal charge/discharge power [kW]	5

Figure 8: Data of the storage «LG Chem»

Figure 9 shows a summary of the resulting size of the PV and battery storage systems, which are considered for the simulation.

Address	Energy consumption per year [kWh] ¹	Nominal PV power based on the rule of thumb [kW]	Number of installed storage systems	Nominal capacity of installed storage system [kWh]
Meikirchstrasse 31	3188.11	4	1	9.3
Meikirchstrasse 34	5671.21	6	1	9.3
Meikirchstrasse 35	3860.81	4	1	9.3
Weissensteinstr. 14	4962.54	5	1	9.3
Meikirchstrasse 20	9041.54	10	2	18.6
Meikirchstrasse 21	4604.52	5	1	9.3
Meikirchstrasse 22	9481.07	10	2	18.6
Meikirchstrasse 10	4656.52	5	1	9.3
Meikirchstrasse 12	3934.76	4	1	9.3
Säriswilstrasse 24	8736.43	9	1	9.3

Figure 9: Size of the PV and storages systems

3.2.3 Verification of the grid model

Due to the lack of measured load profiles and voltage data, the grid model of Schüpfenried could not be verified. However, since the model is based on the actual grid data it does represent the expected behavior of a real grid and is therefore well suited for the following simulations.

¹ The given numbers for the yearly energy consumption are based on the synthetic profiles and do therefore not represent the real consumptions of those clients.

3.2.4 EMS

In PowerFactory a quasi-dynamic simulation model (QDSL model) of an energy management system (EMS) has been implemented (Figure 10). The QDSL model of the EMS provides an abstract form of a real EMS and is not based on the EMS used in the Prosumer-Lab testbench. It is used for a qualitative analysis of different grid situations. Unlike the EMS developed by CSEM, which is controlling the heatpump, this EMS considers only the control of a battery storage system. It has been implemented in such a way that it allows a power-controlled and a voltage-controlled mode. For the following simulation, the EMSs are in power-control mode, which means the charging or discharging power of the battery is defined by the difference in the power of the PV system and the load. If this value exceeds a given threshold of ± 1 kW (in this document referred to as dead band), the storage is charged or discharged. The charging or discharging power corresponds to the difference between the PV power and the load, provided this value does not exceed the nominal power of the storage system. Otherwise, the storage is operated at nominal power.

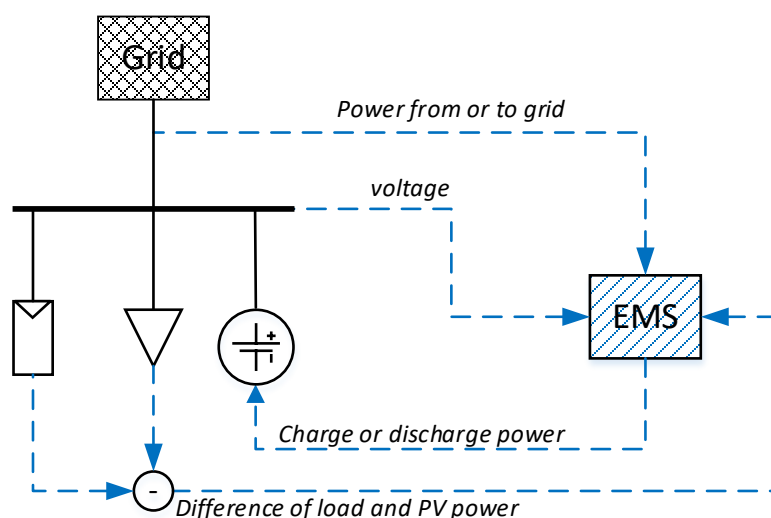

Figure 10: Schematic representation of the EMS model

The EMS, which were used in the Prosumer-Lab, can control the battery as well as a heat pump. The heat pump serves as an additional storage. This allows the EMS to store the surplus of PV power in form of thermal energy in the hot water tanks of the house by activating the heat pump. However, this feature was not considered in the implementation of the EMS in Power Factory. Since from the point of view of the power grid, it does not matter whether the surplus PV power is stored in a chemical storage or thermal storage.

The implemented model of the EMS was verified using a Varta battery (Varta element 6) connected to the Prosumer-Lab. The Varta battery comes with its own EMS. The simulated power profile of the battery, based on the EMS model, shows a difference of max. 10% to the measured one of the Varta battery. Further information about the implementation of the EMS, its testing and the validation are provided in Appendix 15.1.

3.3 Results

Two scenarios were considered in this investigation:

Scenario	Description
1	No one has installed a battery storage system with EMS.
2	Everyone has a battery storage system with EMS in power-controlled mode with a dead band of ± 1 kW

Figure 11 compares the simulated maximum and minimum voltages at all connection points, which have occurred in the two described scenarios. Therefore, those maximum and minimum values form an envelope of the voltages of all simulated grid points. The blue curve represents the situation without EMS and storage system.

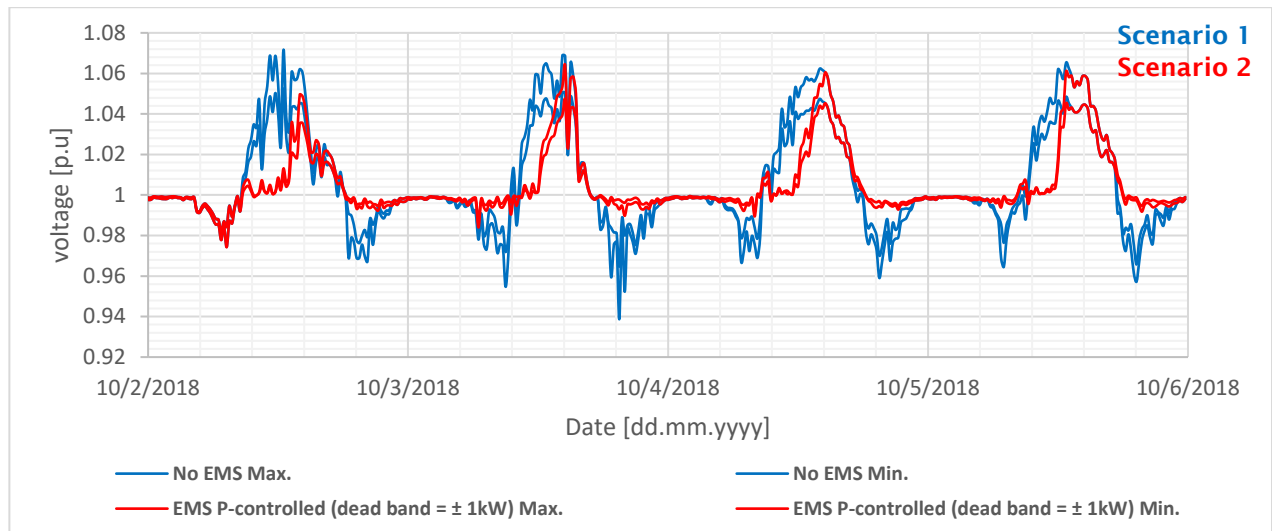

Figure 11: Envelope of the voltages of all simulated grid points

In Figure 12, the loadings of the overhead line which connects the group of customers are shown for the same situation.

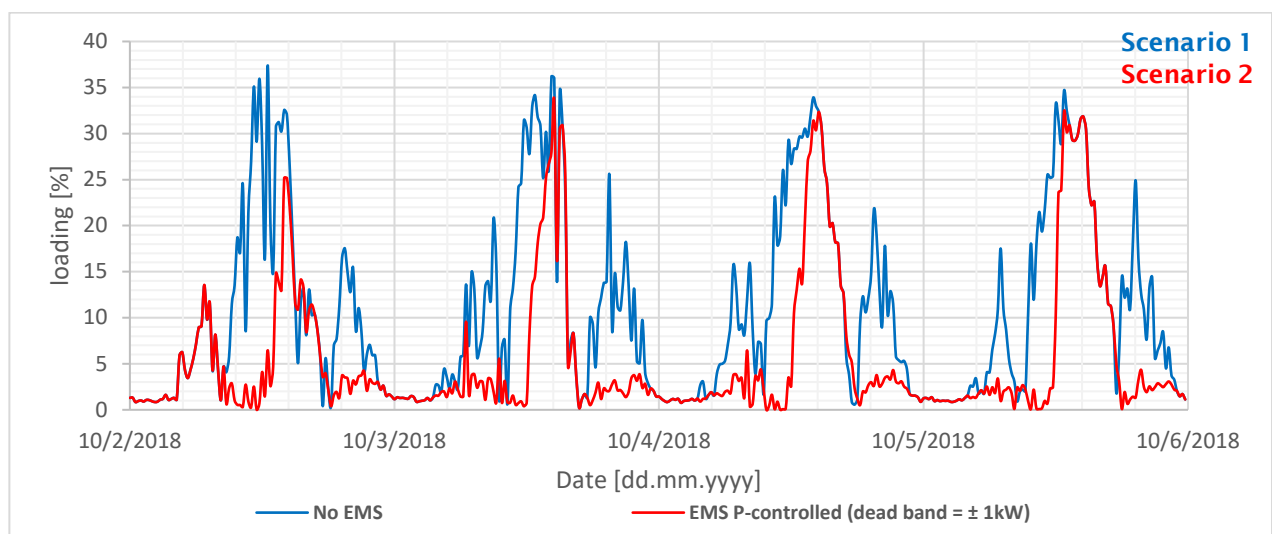

Figure 12: Envelope of the voltages of all simulated grid points

3.4 Discussion

If the PV systems are operated without an EMS and storage system, the voltage in the grid rises by 7% above the nominal value. If the PV systems are operated in combination with a storage system and an EMS with a dead band of ± 1 kW, the first part of the voltage increase can be intercepted by charging the storage with the excess PV power. In the afternoon, however, the storages are fully charged, which forces the EMS to feed the PV power back into the grid, which then results in a strong increase of the voltage (red curves). The same applies to the loading of the overhead line. In the early afternoon, when most of the storage systems are fully charged, the loading increases up to 35%. To counteract this, it would be reasonable to adjust the power dead band of the EMS, depending on the weather, to store just the peak of the PV power.

4 RQ-3002b: EMS with information about weather forecasts

How can the impact of the PV system on the grid stability be reduced when the EMS uses information about the weather forecast to operate the storage?

4.1 Summary

As discussed in Chapter 3, the voltage increase in the grid due to the PV power cannot be intercepted by the EMSs and battery storage systems, if the EMSs are operating with a power dead band of ± 1 kW. Therefore another simulation is considered: In this case, the EMSs have information about the weather forecast and therefore can adapt the power dead band in order to store just the peak power of the PV systems. The simulation has shown that with an upper dead band of 50% of the installed nominal PV power, the voltage increase can be intercepted. However, to get a more satisfying result, either the dead band must be further increased, or the storage systems capacity needs to be increased. This solution would be a good compromise between the customers who want to use all their PV power and the DSO who needs to guarantee grid stability

4.2 Method

The power grid as well as the load and PV profiles for this simulation are the same as already described in chapter 3.2. For the following simulation the EMSs are again set to power-controlled mode. Which means the charging or discharging power of the battery is defined by the difference in the PV power and the load. If the weather forecast data could be read and processed by the EMS an it would predict sunshine for the next couple of hours, the EMS could increase the upper power dead band at which the storage is charged. For this simulation the upper dead band is set to 50% of the nominal installed PV power while the lower dead band is still at -1 kW.

In the following simulation, the three scenarios were considered:

Scenario	Description
1	No one has installed a battery storage system with EMS.
3	Everyone has a battery storage system with EMS in power-controlled mode with an upper dead band of $\frac{1}{2}$ the nominal PV power and a lower dead band of - 1 kW.
4	Same as Scenario 3 but with doubled storage capacity

Figure 13 shows a summary of the resulting size of the PV and storage systems which are considered for the simulation.

Address	Nominal PV power based on the rule of thumb [kW]	Upper power dead band for charging the storage[kW]	storage systems for scenario 1 [kWh]	storage systems for scenario 2 [kWh]
Meikirchstrasse 31	4	2	9.3	18.6
Meikirchstrasse 34	6	3	9.3	18.6
Meikirchstrasse 35	4	2	9.3	18.6
Weissensteinstr. 14	5	2.5	9.3	18.6
Meikirchstrasse 20	10	5	18.6	37.2
Meikirchstrasse 21	5	2.5	9.3	18.6
Meikirchstrasse 22	10	5	18.6	37.2
Meikirchstrasse 10	5	2.5	9.3	18.6
Meikirchstrasse 12	4	2	9.3	18.6
Säriswilstrasse 24	9	4.5	9.3	18.6

Figure 13: Size of the PV and storage systems and the definition of the upper dead band in order to charge the storage

4.3 Results

Figure 11 shows the envelope of the voltages at all simulated connection points, meaning all the values are somewhere in the area between the two lines of the same color. The blue curve represents the situation without EMS and storage system.

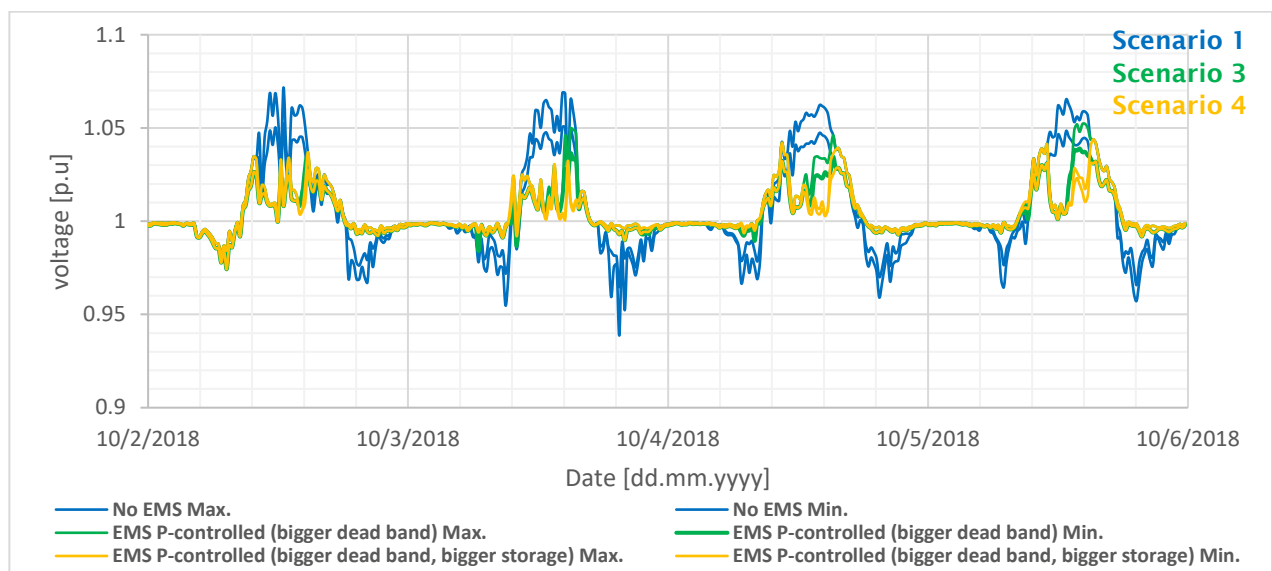

In Figure 12, the loadings of the overhead line connecting the group of customers are shown for the same situation. Even under the worst condition, the loading of this line is far from critical. Regarding the loading, there is still a lot of potential for additional loads and PV systems.

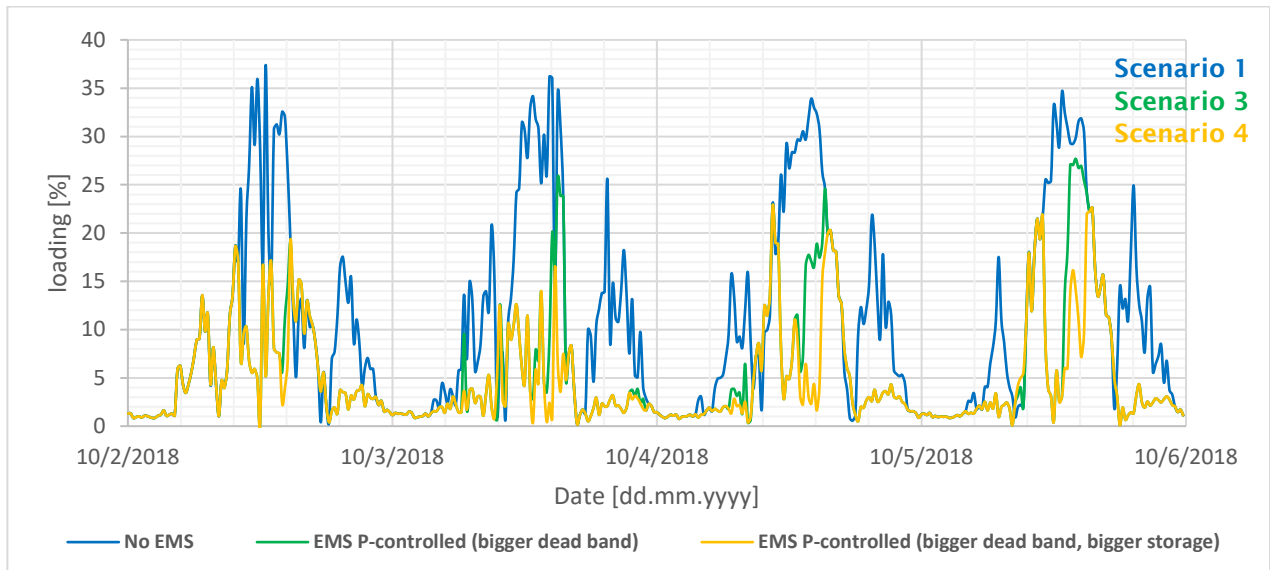

Figure 15: Loadings of the overhead line

4.4 Discussion

As the simulation has shown, it would be beneficial to increase the upper dead band, as soon as weather forecasts predict a good weather period. This allows the EMS to store the peak power of the PV system (peak shaving) and thus reducing the high peak voltage in the afternoon (green curve). As the simulation shows, the situation can be further improved if, in addition, the storage capacity is doubled (yellow curve). Another solution would be to further increase the dead band. The same applies to the loading of the overhead line.

5 RQ-3002c: Strategies to stabilize the grid

What must be considered if the EMS is controlling the operation of the storage based on the voltage measured at its connection point?

5.1 Summary

In the previous simulations, the power-controlled EMSs were considered. Those are more orientated to increase the self-consumption rate of the customers rather than stabilizing the grid. In this simulation the behavior of a voltage-controlled EMS is investigated.

The main goal of the voltage-controlled EMS is not to increase the self-consumption rate of the customer, but to increase the grid stability. It is therefore more interesting to the DSO rather than the customer. The simulations have shown, that to get a satisfying result the EMS needs to be parametrized correctly. Otherwise, oscillations of power and voltage can occur. It could be shown that in case of this grid, the voltage rise during the day can be decreased by 3% with the voltage-controlled EMS.

5.2 Method

The load and PV profiles, as well as the dimensioning of the PV and storage system, for this simulation are the same as already described in chapter 3.2. For the following simulation, the EMSs are set to voltage-controlled mode. This means that the charging or discharging power of the battery is defined by the voltage at its connection point. The EMS needs to set the charge or discharge power of the storage, depending on how much the voltage at the connection point is outside of a given threshold (in this document referred to as the dead band). If the EMS would just set a constant charge or discharge power whenever the voltage is outside the dead band, the system would start to oscillate.

For this reason, the EMS must have a droop assigned. The droop determines how sensitive the EMS sets the storage power, depending on a specific voltage change. With a very high droop, the charge or discharge power of the storage is adjusted very strongly, even when the change in the voltage is very small, which may result in an oscillating behavior. An infinitely large droop results in the behavior of the voltage as shown in Figure 17. On the other hand, with a droop value of zero, the EMS shows no response to a change in voltage at all. The storage power remains independent of the voltage at 0 p.u. Figure 16 shows the storage power set by the EMS as a function of the voltage at the connection point for different droop values. Within the dead band of $\pm 2\%$ of the rated voltage, the storage power remains at 0 p.u. Since the voltage in the grid is never quite constant, this dead band is essential to prevent unnecessary charging or discharging of the storage to maximize its lifetime. Outside the dead band, the straight line has a slope of 25 W/V, this value corresponds to the droop. With a droop value of 25 W/V, the storage is operated at rated power (5 kW for the LG Chem RESU10H) as soon as the voltage changes by approximately $\pm 6\%$.

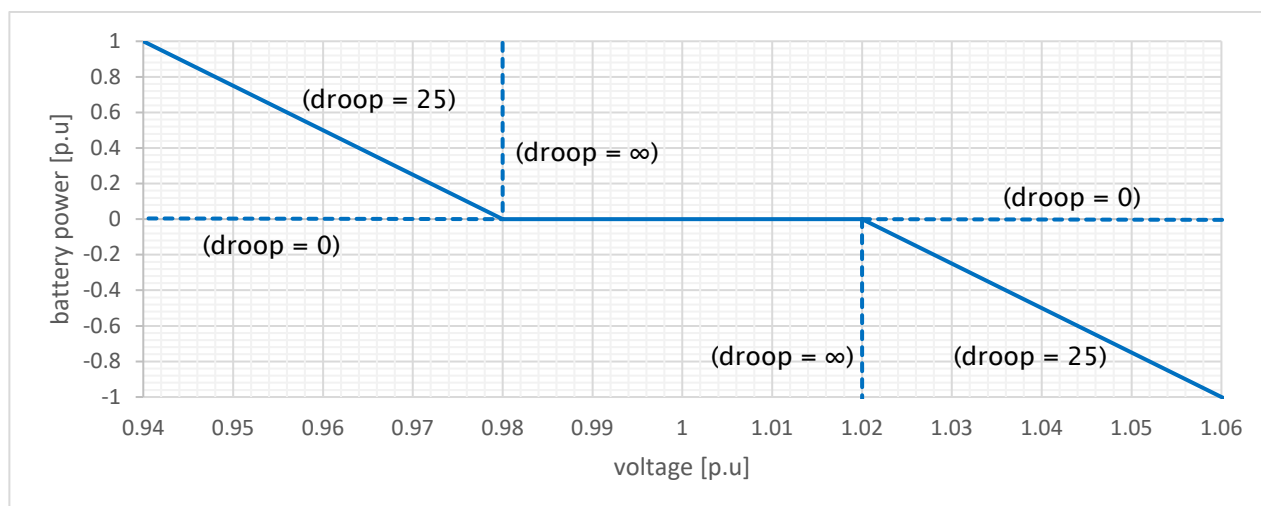

Figure 16: Relation between change in voltage and the resulting storage power set by the EMS for different droop values

Further information about the implementation of the EMS and its testing are provided in appendix 15.1.2.

In the following simulation, the two scenarios were considered:

Scenario	Description
1	No one has installed a battery storage system with EMS.
5	Everyone has a battery storage system with EMS in voltage-controlled mode

5.3 Results

Figure 17 shows the envelope of the voltages of all simulated connection points when the EMS is operating in voltage-controlled mode. The storages are charged when the voltage at the connection point exceeds the dead band of 1.02 / 0.99 p.u. In this case, no droop is assigned to the EMS which means as soon as the voltage exceeds the dead band, the storage is either charged or discharged with the maximum possible power. This charging or discharge power corresponds to the difference between the power of the PV system and the load, provided that this value does not exceed the nominal power of the storage. Otherwise, the storage is operated at rated power.

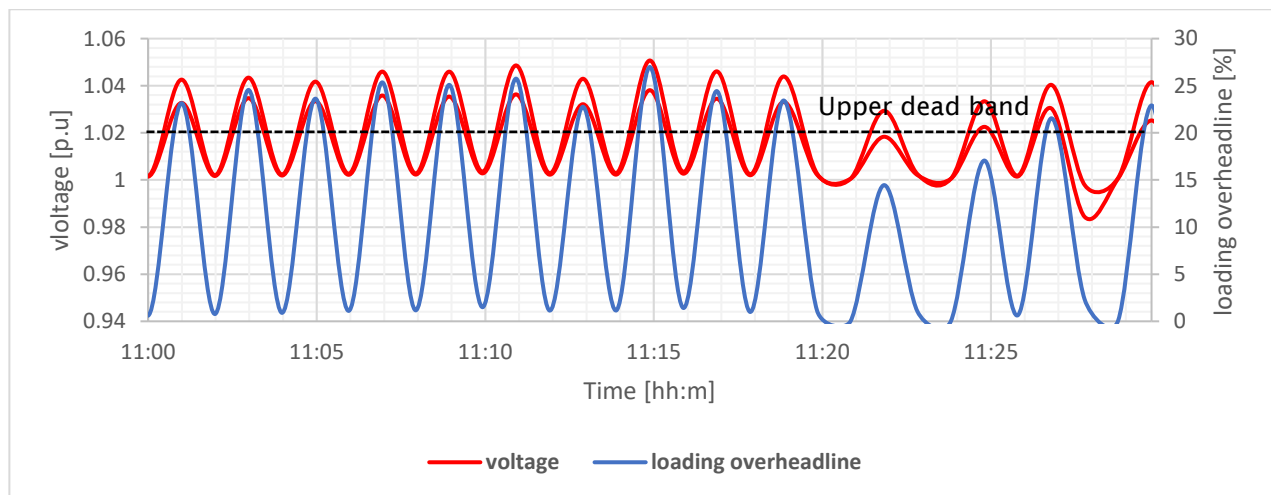

Figure 17: Envelope of the simulated voltages at all connection points as well as the loading of the overhead line when the EMS are operating in voltage-controlled mode without any droop value assigned (respectively with a droop value of ∞)

Figure 18 shows the envelope of the simulated voltages at all connection points when all the EMSs are operating in voltage-controlled mode with a droop value of 25 W/V.

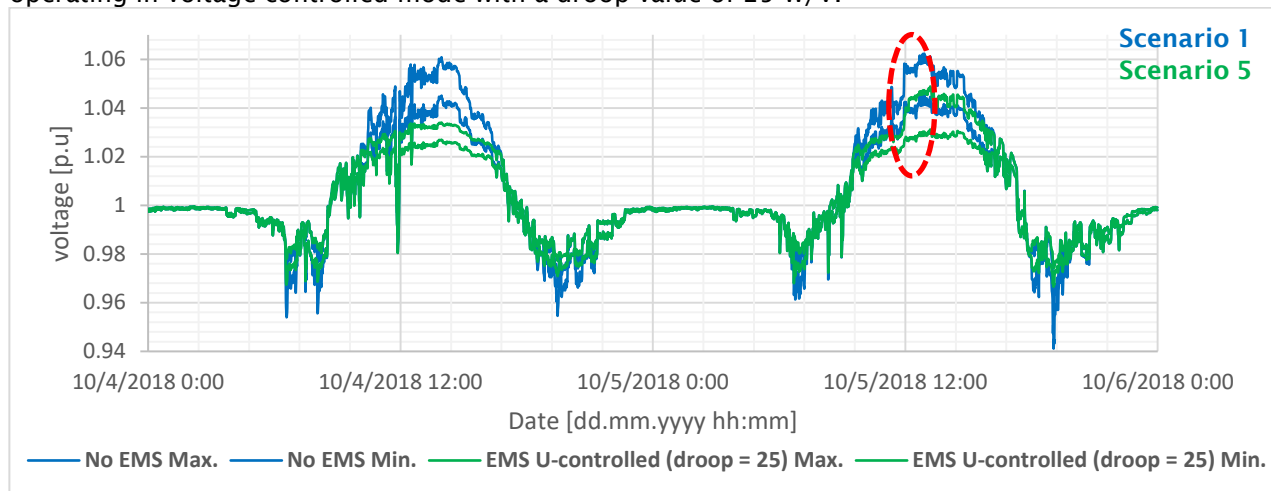

Figure 18: Envelope of the simulated voltages at all connection points when all the EMS are operating in voltage-controlled mode with a droop value of 25 W/V

In Figure 19 the loadings of the overhead line, which connects the group of customers, is shown for the same situation.

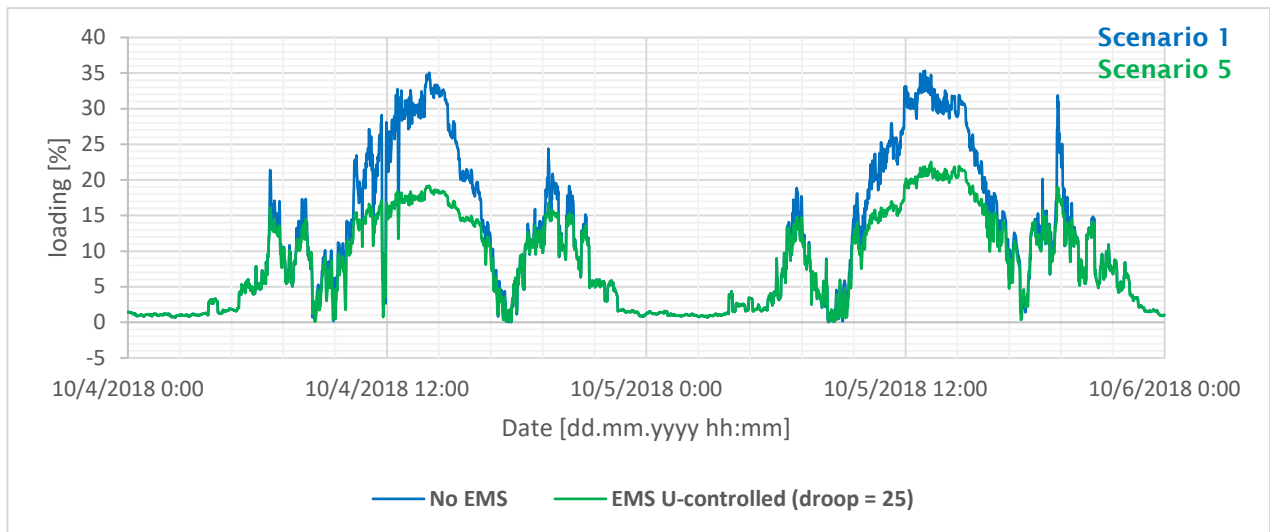

Figure 19: Loading of the overhead line when all the EMS are operating in voltage-controlled mode with a droop value of 25 V/W

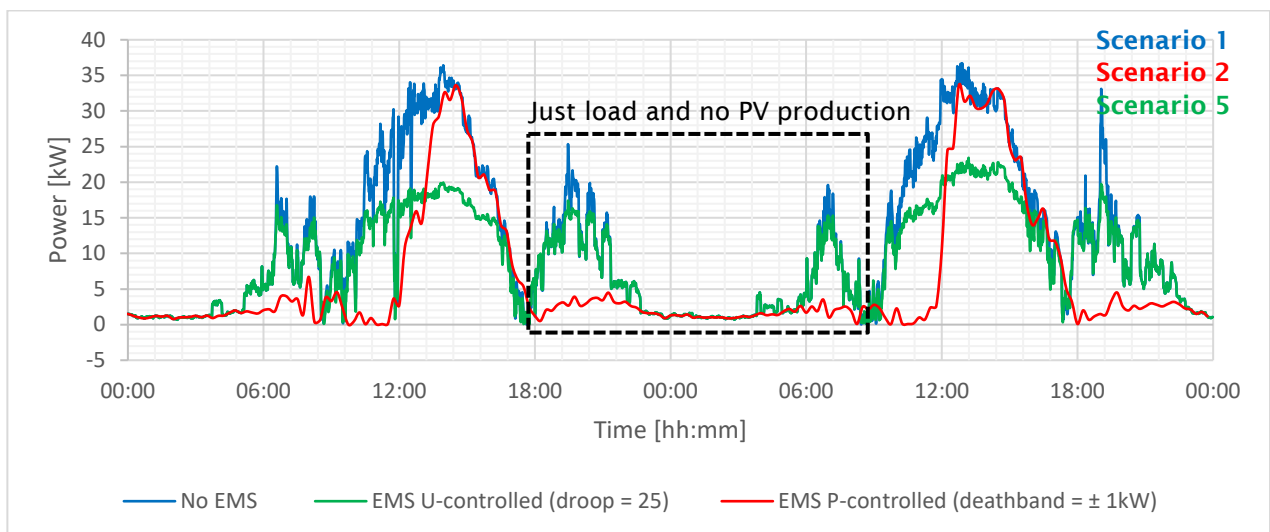

Figure 20: Power flow in the overhead line when all the EMS are operating either in voltage-controlled mode or in power-controlled mode

5.4 Discussion

In Figure 17, it can be clearly seen that whenever the voltage is outside the dead band limit, the EMS over-modifies the charge and discharge power of the storage, resulting in an oscillating behavior of the voltage as well as the loading of the overhead line. The voltage-controlled operating mode of the EMS without any droop assigned to it, is therefore unsuitable. However, the operation of the voltage-controlled EMS with a droop, which is shown in Figure 10, leads to a better behavior. In this case, it is easy to see that no oscillations occur and the maximum voltage can be reduced by up to 3%. A similar behavior can be seen, considering the loading of the overhead line in Figure 19. Due to the EMS, the loading can be reduced by half.

The voltage increase during the day caused by the PV power is smoothly cut off in this operating mode. This is in contrast with the case of power-controlled mode, where as soon as the power exceeds the dead band, all the PV power is stored, causing a sudden drop of the voltage at the terminal (Figure 14).

5.4.1 Parameterization of EMS

The optimal droop for each voltage-controlled EMS in the grid depends on the maximum and minimum voltage at its connection point and must be defined individually for each EMS. An incorrect parameterization can lead to an oscillating behavior of the EMS. To determine the optimum droop value, a simulation was first carried out with all the EMS deactivated. Then the obtained maximum voltage was set as a reference for the parameterization according to the formula shown below, which leads to a droop value of 25 W/V. The same calculation based on the minimum voltage in the grid would result in a droop value of 50 W/V. This value, however, would lead to an oscillating behavior during the day, because the EMS would react too sensitively to a voltage change. It is therefore advisable to always choose the smaller droop value for the given EMS to prevent any oscillation behavior in the system (Figure 16).

$$droop = \frac{P_{Charge}}{U_{Max} - U_{upper\ dead\ band}} = \frac{1}{1.06 - 1.02} = 25 \frac{W}{V}$$

$$droop = \frac{P_{Discharge}}{U_{Min} - U_{lower\ dead\ band}} = \frac{-1}{0.96 - 0.98} = 50 \frac{W}{V}$$

This process of parameterization as described is also recommended for the use of a voltage-controlled EMS in practice. The maximum and minimum voltages in the grid depend on the season. In summer, where the power fed in by the PV systems is in general much higher, the maximum voltage reaches higher values than in winter. During the winter however, the PV power is lower, and the loads tend to be higher. This leads to lower voltage values during the winter. Thus, the optimal value for the droop of a voltage-controlled EMS also depends on the season. For this reason, the process of EMS parameterization must be repeated regularly, e.g. on a monthly basis, as shown in Figure 21. This means that the EMS needs to temporarily stop the operation of the storage for one day, measure the resulting voltage at the connection point and calculate the value for the droop.

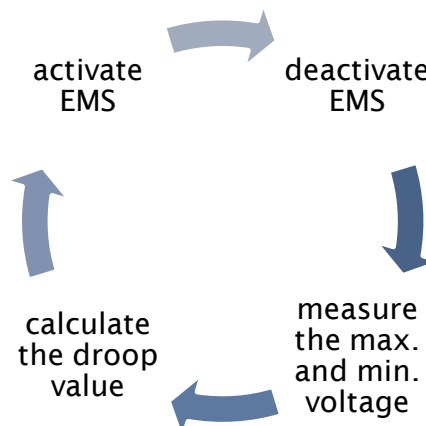

Figure 21: Process of parameterizing a voltage-controlled EMS

5.4.2 Drawback of this solution

In Figure 18 it can be seen, that on the second day around noon the voltage seems to increase abruptly (red mark). This occurs, because at this time, most of the storages in the grid are fully charged and the PV power is fed into the grid, which causes the voltage to increase. The problem is that with a droop value of 25, during the evening the EMSs will not adequately discharge the storage systems. Because in the voltage-controlled mode, the EMS sets the discharge power of the storage according to how much the voltage is below the dead band limit. In this scenario, the voltage does not decrease enough in the evening, since the loads are too small. Therefore, the discharge power is not set to a reasonably high value by the EMS in order to use the whole energy stored in the storage systems. This requires a solution. One solution would be to set a time-dependent droop value for each EMS. So that during the day when the voltage increases are high, the EMS won't react too sensitively to any voltage change. However, during the night, the EMS would have a higher droop value, so that even for a small drop in the voltage, the storage discharge power is increased enough to use all the stored energy. Another

solution would be to change the mode of the EMS during the night to power-controlled mode. Then the whole energy demand of the household can be met by discharging its storage. This would be a good compromise between the grid company, who requires a stable grid, and the customer, who wants to increase own-consumption.

Furthermore, it is important to add, that the simulations were all done on a quasi-dynamic basis. This means the simulation consists of a series of discrete independent timesteps. Therefore, the variables in the quasi-dynamic simulations are independent of time. This could also be a reason for the observed oscillations. In a dynamic simulation on the other hand, all the variables, e.g. the voltages, are considered to be time-dependent. Meaning the simulations are done in a continuous way, which could lead to a slightly different behavior of the EMS. Therefore, to further analyze the subject of the voltage-controlled EMS, it is recommended to also consider using a dynamic simulation.

5.4.3 Self-consumption vs grid stability

Figure 20 shows the load flow in the overhead line in this situation (scenario 5) compared to the situation where all the EMSs are in power-controlled mode with a dead band of ± 1 kW (scenario 2). In the morning and evening the power flow in scenario 5 is significantly higher compared to scenario 2. This is because scenario 2 is focused only on the improvement of the self-consumption. In other words, the main goal of the EMSs is to store as much PV power as possible and use all the stored power later in the evening. The voltage-controlled EMSs on the other hand are focused on the improvement of the grid stability. Compared to the situation without EMS (Scenario 1), the load flow, i.e. the consumption from the grid, can be reduced in the evening by up to 20 kW with the power-controlled EMS. That means all the customers are using the power from their own storages. While with the voltage-controlled EMS the load flow can only be reduced by around 6 kW (black mark in Figure 20). Therefore the customers still have to buy energy from the grid in order to cover their consumption. This shows that the improvement of the grid stability and the increasing of self-consumption are rather conflicting goals.

6 RQ-3003: Quantified potential of EMSs to stabilize the grid

How do the several simulated configurations of the EMSs look in terms of potential to stabilize the grid when compared to each other.

6.1 Summary

In this chapter, the various configurations of the EMSs from chapter 3 to 5 are compared, in terms of efficiency in stabilizing the grid. It could be shown that the most effective way to stabilize the voltage is with a power-controlled EMS with a weather-dependent dead band and larger storage capacity². The voltage-controlled EMS seems to have a less-significant effect on the voltage, which however strongly depends on the droop value.

6.2 Method

To quantify the previous simulation results in terms of potential to stabilize the grid, the following procedure was chosen. The situation where no customers have an EMS is defined as a reference scenario. Then the difference in percentage between the voltage occurring in the reference scenario (scenario 1) and the voltage occurring during the various configurations of the EMSs is calculated. The same difference is calculated for the overhead-line loading.

The following scenarios were considered:

Scenario	Description
1	No one has installed a battery storage system with EMS.
2	Everyone has a battery storage system with EMS in power-controlled mode with a dead band of ± 1 kW
3	Everyone has a battery storage system with EMS in power-controlled mode with an upper dead band of $\frac{1}{2}$ the nominal PV power and a lower dead band of $- 1$ kW.
4	Same as Scenario 3 but with doubled storage capacity
5	Everyone has a battery storage system with EMS in voltage-controlled mode

² The terms «larger storage» and «bigger dead band» are referring to the values shown in Figure 13

6.3 Results

Figure 22 shows the percentage change in voltage between the reference scenario and the various configurations of the EMSs.

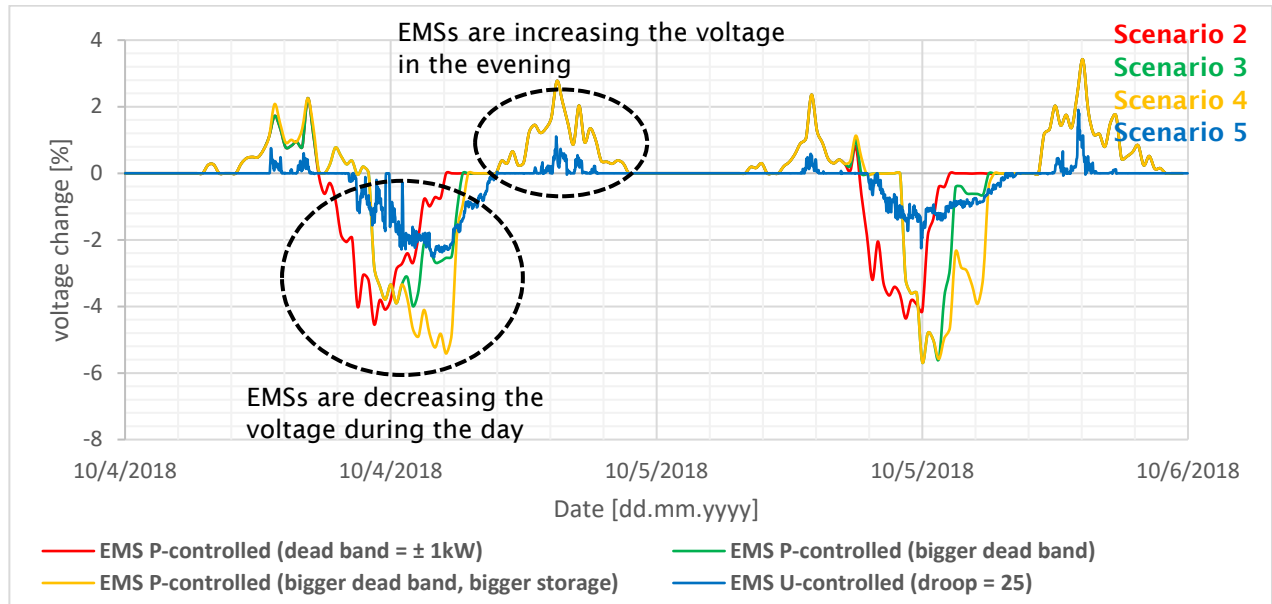

Figure 22: change of voltage in percent between the reference scenario and the various configurations of the EMSs

Figure 23 shows the percentage change in the loading of the overhead line between the reference scenario and the various configuration of the EMSs. -100% means that the EMSs can reduce the loading of the line to 0 %, since all the PV power is stored.

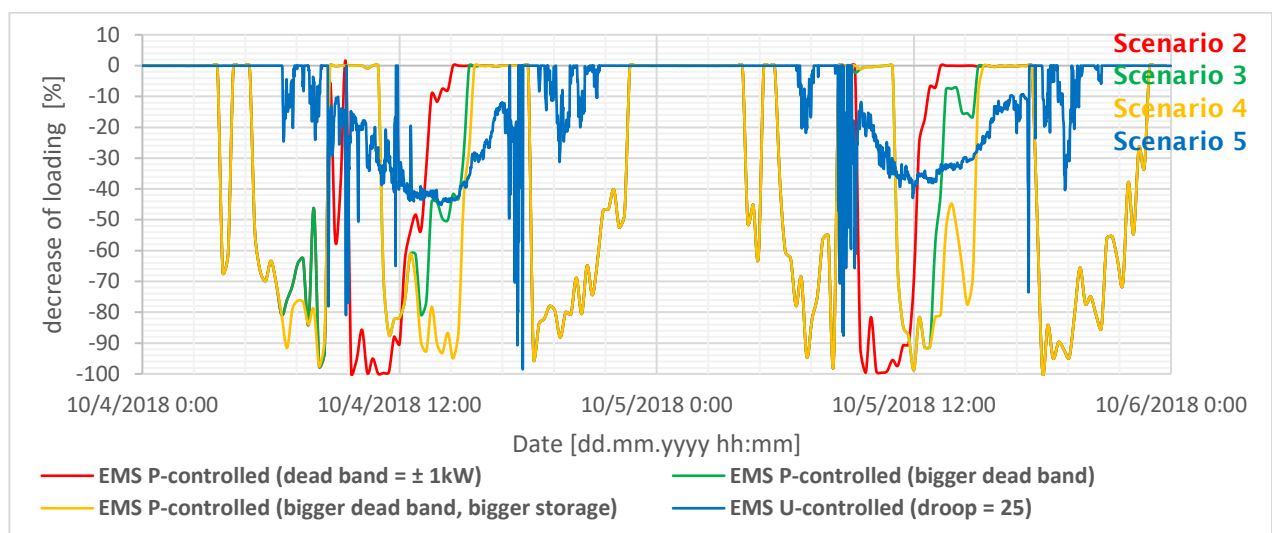

Figure 23: Change of the line loading in percent between the reference scenario and the various configuration of the EMSs

6.4 Discussion

As shown in Figure 22 the rise of the voltage due to the PV power can be damped up to almost 6%, thanks to the EMSs. The problem with the configuration of the power-controlled EMS with a dead band of ± 1 kW is that the voltage can be stabilized only in the first half of the day. After that, all the storages in the grid are mostly fully charged and the potential to stabilize the grid decreases to zero (red curve). The increase of the dead band as a function of the weather forecast (green and yellow curve) results in a longer period of the day where the voltage can be reduced with the EMSs. It can be seen that the

power-controlled EMS are, in general, able to decrease the voltage significantly, while the voltage-controlled EMS only decreases the voltage by up to 2.5%. This is due to the fact, that the voltage-controlled EMS need to have a droop value assigned, which determines how sensitive the charging power of the storage is set, depending on a specific change in the voltage. As described in Chapter 5, the higher the droop is, the larger the storage power will be which results in a more significant influence of the EMSs on the voltage. However, a droop value, which is too high, can result in oscillations.

On the other hand, in the morning as well as in the evening the potential to stabilize the grid, which in this case means the reduction of the voltage drop due to the load, can be reduced by up to 4% by all the various EMS configuration. It should be added, that all the power-controlled EMSs have the same lower dead band of -1 kW. Only the upper dead band was changed in the various configurations.

The same applies for the loading of the overhead line in Figure 23. With the power-controlled EMS, the loading of the overhead line can be reduced by up to 100%, whereas with the voltage-controlled EMS the loading can only be decreased by circa 40% (there are several spikes, but those are negligible).

The simulations were done for a period of four days; however Figure 22 just shows a single day. If all the storages were empty in the morning and again in the evening, after being charged during the day, the integral of the functions would be 0. However, this is not the case in these simulations, since the storages are not discharged completely in the evening.

To conclude, in terms of grid stabilization the power-controlled EMS seems to be more efficient than the voltage-controlled EMS, but only for the ones with a bigger dead band (green and yellow curve in Figure 22). The EMS with the dead band of 1 kW won't decrease the voltage during the whole day, which will lead to a strong increase of the voltage in the afternoon. From the point of view of the DSO, this configuration is therefore not ideal. The most efficient configuration would be the power-controlled EMS with an increased dead band and a bigger storage capacity (yellow curve in Figure 22). This configuration allows one to eliminate the complete peak of the PV power and therefore reduce the voltage increase in a most efficient way. However, if the customer is not willing to invest in a larger storage, the configuration with the EMS with a storage, based on the rule of thumb and bigger dead band, also delivers a satisfying result for the DSO (green curve in Figure 22).

7 RQ-3004: Impact on the grid stability in case of a malfunction of the EMSs

How severe is the impact on the grid stability in the case of a malfunctioning EMS?

7.1 Summary

This chapter analyzes the stability of the grid during an EMS failure. It was assumed that, due to a malfunction of the EMS, all storage systems in the grid were charged simultaneously during the evening with nominal charging power. This leads to a situation where the charging power of the storages is added to the loads. As the simulation has shown, this scenario would lead to voltages in the grid down to 0.79 p.u., whereas the overhead line would reach a loading of 95%.

7.2 Method

The load and PV profiles as well as the dimensioning of the PV and storage system for this simulation are the same as that described in chapter 3.2. It is assumed that the EMSs feature a communication interface, which enables the DSO to either control the EMSs or check the system status. In the evening at 19:30 due to a malfunction of the communication interface, some of the storage systems in the grid are being charged. In addition, since the PV systems have stopped their production at this time, the storages are charged with energy from the grid. Whereas the charging power is assumed to be the nominal value of the storage system as written in Figure 8.

7.3 Results

Figure 24 shows on the y-axis the simulated voltage at Weissensteinstrasse 14 as well as the loading of the overhead line. The x-axis represents the number of malfunctioning EMSs in the grid. Due to its distance from the transformer station, the Weissensteinstrasse 14 is the most critical connection point in the grid.

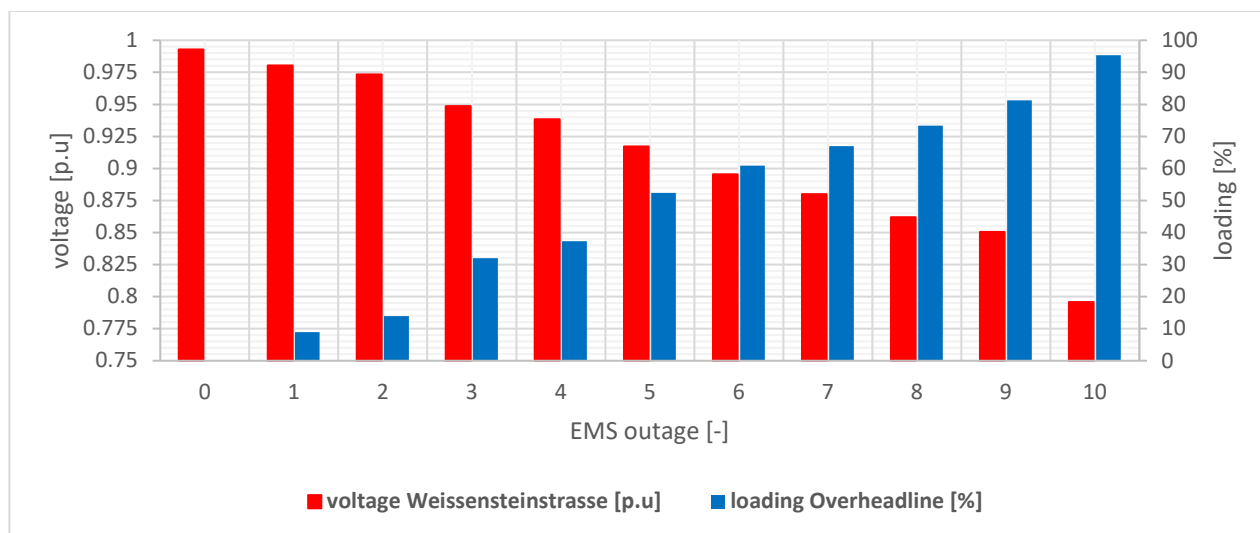

Figure 24: simulated voltage at Weissensteinstrasse 14 as well as the loading of the overhead line, depending on the number of malfunctioning EMS

Figure 25 and Figure 26 are showing the voltage at the terminal of the Weissensteinstrasse 14 and the loading of the overhead depending on the time, when there is a malfunction of all the EMSs in the grid and all the storages are being charged at 19:30 with nominal power.

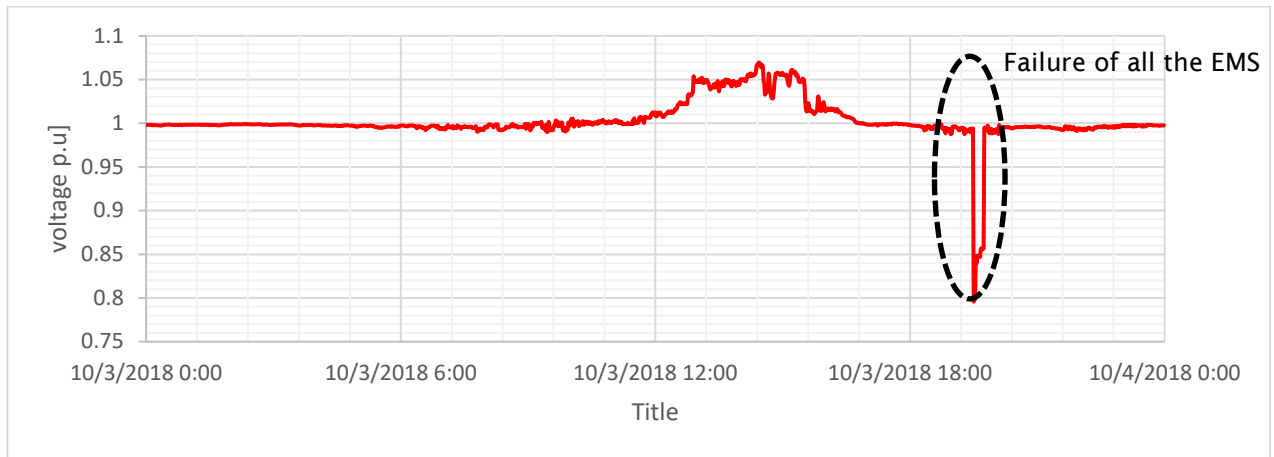

Figure 25: voltage at the terminal of the Weissensteinstrasse 14 when there is a malfunction of all the EMS in the grid

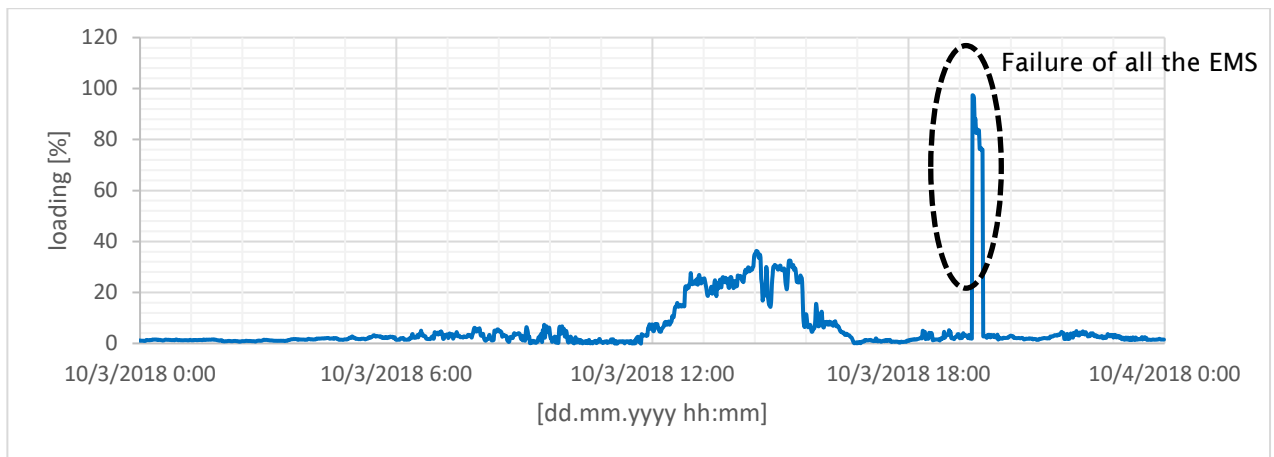

Figure 26: loading of the overhead line when there is a malfunction of all the EMS in the grid

7.4 Discussion

If there is a malfunction of all the EMSs in the grid for which reason all the storages are charged in the evening, the voltage at Weissensteinstrasse 14 drops down to 0.79 p.u. This value is lower than the minimal permitted voltage of 0.85 p.u. given by the EN50160. This scenario should therefore be avoided, if at all possible. The overhead line, on the other hand, reaches a loading of 95%. Therefore, it would be possible to, at least temporarily, continue the operation of the overhead line in this scenario. The loading of the other lines in the analyzed grid are all smaller than the one of the overhead line.

Since the analyzed part of the grid is rather far away from the TS and the TS itself is located in a rural region, the short circuit power in this grid is rather low (0.7 MVA at the end of the overhead line according to a short circuit simulation). Therefore, the malfunction of those ten EMSs already leads to a strong decrease of the voltage to about 0.79 p.u. If an urban grid with rather short lines from the TS to the customers would be considered, the short circuit power would be much higher. Therefore, the voltage drop would be less significant. Thus, a similar simulation needs to be performed for each grid individually to determine the worst-case scenario in case of a malfunction of the EMS.

As described in chapter 3.2.4, the EMS implemented in Power Factory does not consider the control of a potential heat pump. However, from the point of view of the power-grid, the only thing that matters in this case is the power flow at the connection point of each house. Thus, the results of this simulation are also valid for the case of a malfunction of the EMS in which all the heat pumps are started instead of charging all of the storage systems.

8 RQ-3005: PV growth according to «Energiestrategie 2050»,

How big is the impact on the power grid if the energy production with PV systems increases according to the «Energiestrategie 2050» and what is a possible solution considering the EMSs?

8.1 Summary

One scenario of the «Energiestrategie 2050» requires a total of 11'036 GWh energy per year produced by PV systems. This leads to a total of 44.8% of the available roof space of every house in Switzerland which needs to be equipped with a PV system. In the analyzed part of the Schüpfenried grid, many of the houses are farmhouses with large roofs. In such a case an EMS and storage system for every single house would be less interesting for the prosumer, since the consumption of the house is very small compared to the resulting PV production. A possible solution would be a central storage with an EMS somewhere in the low voltage grid, e.g. next to the transformer station or, as in this case, at the end of the main supply line. It could be shown that, up to a certain point, the PV growth predicted by the «Energiestrategie 2050» can be managed with the help of a central storage system with an EMS. In this case, however, it would still be advisable to reinforce the main supply line, i.e. the overhead line, in order to keep the voltage in an acceptable range.

8.2 Method

8.2.1 PV-potential according to «Energiestrategie 2050»

The combined power of all the PV systems in Switzerland is around 1664 MW and contributes to a yearly energy yield of around 1.58 TWh [2]. The «Energiestrategie 2050» is considering several alternatives regarding the growth of PV systems for the future. The more optimistic alternatives are predicting a yearly energy production of 11 TWh with PV systems [3].

	Alternative C	Alternative C & E / Alternative E*
energy production with PV systems [GWh/a]	5839	11036

Figure 27: energy production with PV systems according to the «Energiestrategie 2050» [3]

According to a study from «Metetest AG» a yearly energy yield of 24.6 TWh would be possible if all the available space on every roof in Switzerland would be covered with a PV system [4]. It should be mentioned that this value is based on the sustainable potential of available roof space for PV systems, which is the intersection of the economical, the cultural and the social potential of available roof space as shown in Figure 28.

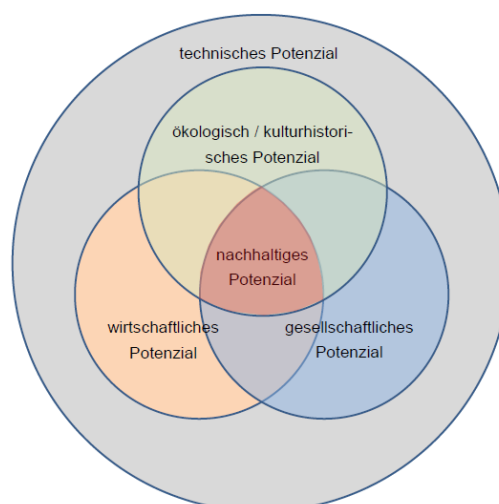

Figure 28: intersection of several potentials in terms roof space suitable for PV systems

From those two values it is easy to calculate the percentage of the total area of the roof for every house in Switzerland, which needs to be covered with a PV-system to get to the total yearly energy of 11036 GWh.

$$\text{Area covered with PV on every roof} = \frac{11.036 \text{ TWh/a}}{24.6 \text{ TWh/a}} * 100 = 44.8\%$$

8.2.2 EMS and central storage system

In the analyzed part of the grid, most of the houses are farm houses with very large roofs. If every customer installs a PV system the size of 45% of the available roof space, those PV systems would be drastically oversized. In such a case an EMS and a storage system for every single house would be unnecessary, since the consumption of the household is very small, compared to the production. Furthermore, a suitably sized storage that is compatible with the installed PV system would turn out to be a large investment, which might not be affordable for the customer. A more economical solution would be to install one EMS with one central storage system. This solution would have the following advantages and disadvantages compared to an EMS and a storage system for every single house (Figure 29):

advantages	disadvantages
<ul style="list-style-type: none"> • More economical and ecologically since only one big storage is needed instead of several small ones. • Easier in maintenance • Easier to control and parametrize since the DSO only must take care for one storage 	<ul style="list-style-type: none"> • Only the loading of the main supply line can be reduced with the central storage. The lines to the customers still have to carry the whole PV power of the installed systems.

Figure 29: advantages and disadvantages of the central storage with EMS compared to an EMS and a storage system for every single house

A possible way to do so is shown in Figure 30, where the central storage system would be installed right at the end of the overhead line. Furthermore, in Figure 30 next to each load the available roof space for each house is given, as well as the resulting nominal size of the PV system, when 44.8% of the roof is covered with PV modules.

For the following simulation, the central EMS is in power-controlled mode, which means the charging or discharging power of the battery is defined by the difference between the combined power of all the PV systems and the total load, measured at the end of the overhead line. If this value exceeds the dead band of 50 kW, the storage is charged or discharged.

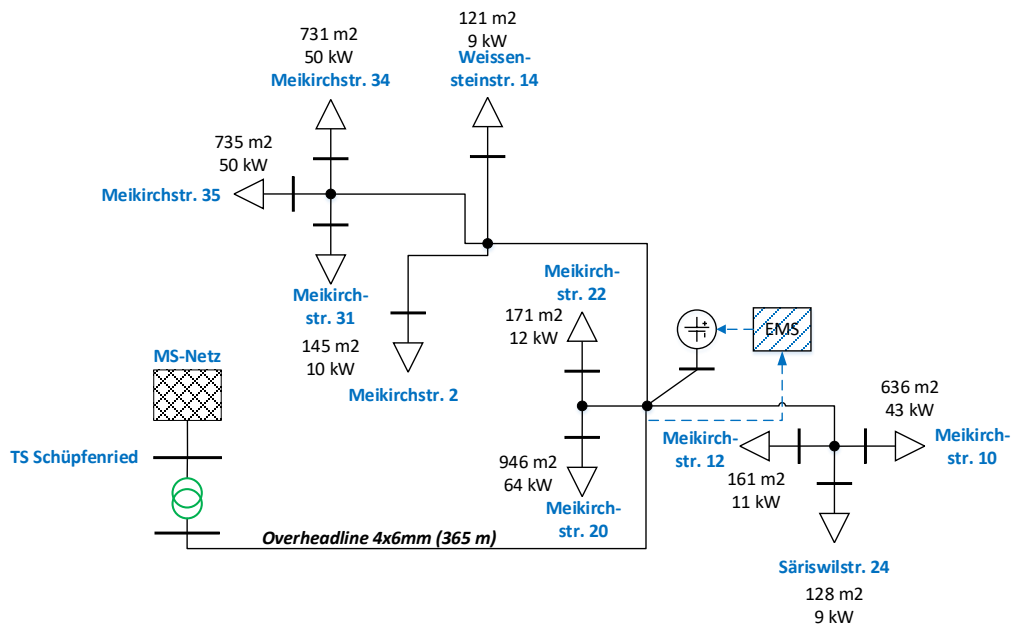

Figure 30: Scheme of the analyzed part of the power grid with a central EMS and storage system. Next to each load the roof size and nominal PV power is given

8.2.3 Dimensioning of the central storage

The total nominal PV power installed in the grid in this case is about 267 kW. According to the rule of thumb as described in Figure 7, the appropriate storage size would be 267 kWh. However, as the simulations has shown, this storage capacity would be too small in this case. On a sunny day the central storage would be fully charged before noon and thus not be able to store the peak of the PV power. To prevent this, either the dead band range (i.e. the PV power that needs to be reached in order to start charging the storage) should be increased, or the storage needs to have a larger capacity. For this approach, a larger storage is chosen, dimensioned as follows:

$$\begin{aligned} \text{total PV Power} &= 267 \text{ kW} \\ \text{Storage Capacity} &= 4h * \text{total PV Power} = 1068 \text{ kWh} \end{aligned}$$

Since the overall load in this particular grid is too small to discharge the central storage on its own, the energy needs to be fed back into the grid during the nighttime. On the one hand, the discharge power must be large enough to discharge the whole storage during the night. On the other hand, the discharge power must not be too large, such that the voltage at the connection point of the storage or the loading of the overhead line would reach a critical value. For the system considered, the following discharge power has turned out to be reasonable, assuming the storage is being discharged from 8 pm to 8 am.

$$\text{Discharge power} = \frac{\text{Storage Capacity}}{\text{Discharge time}} = \frac{1068 \text{ kWh}}{12 \text{ h}} = 89 \text{ kW}$$

8.3 Results

Figure 31 and Figure 32 show the resulting maximal voltage at the connection point of the central storage and the loading of the overhead line. The red line represents the situation with an EMS and a central storage system, whereas the black line represents the situation without an EMS and storage system. In Figure 33, the resulting state of charge of the central storage system can be seen.

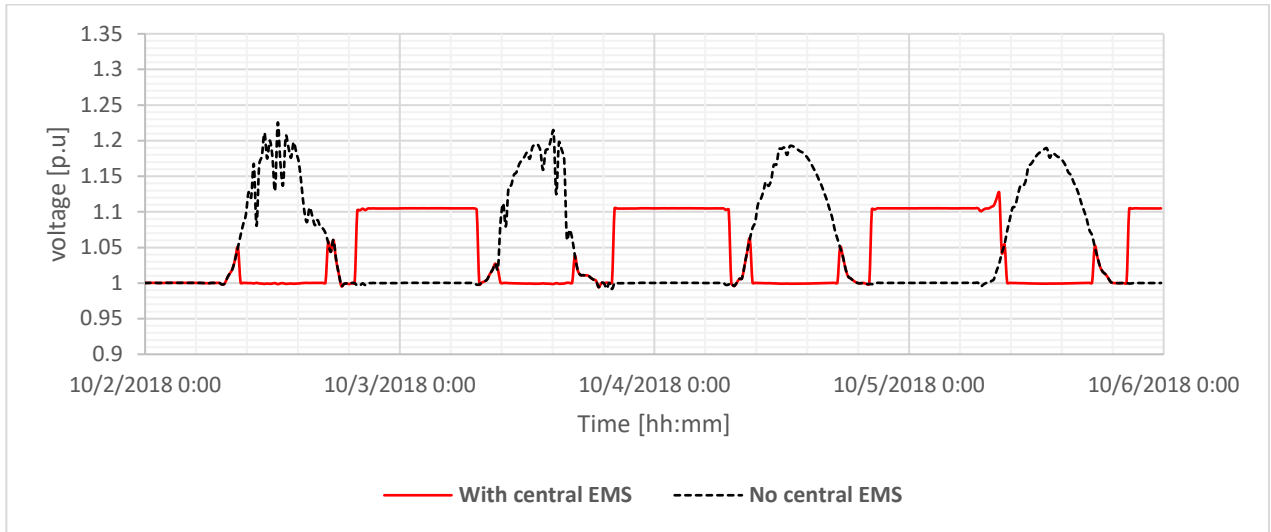

Figure 31: voltage at the connection point of the central storage

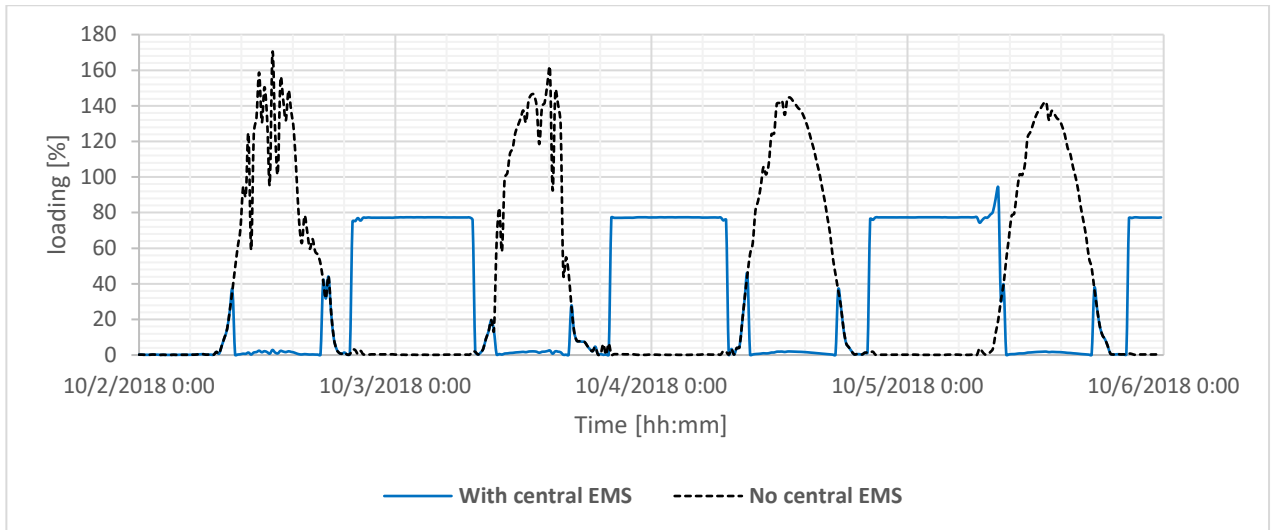

Figure 32: loading of the overhead line

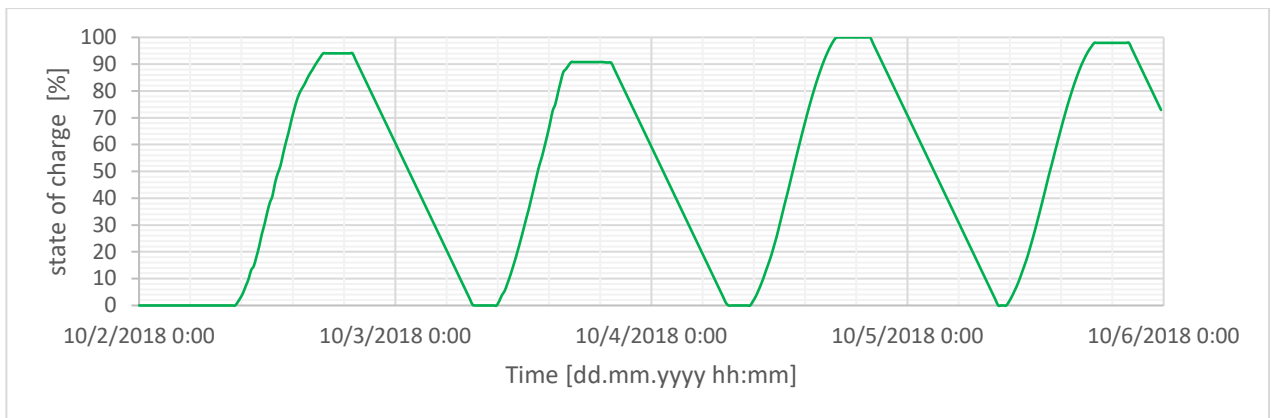

Figure 33: state of charge of the central storage

8.4 Discussion

If the scenario comes true that every customer in the analyzed grid would install a PV system half the size of the available roof space, the increase of the voltage on a sunny day, as well as the loading of

the overhead line, would be tremendous. This situation is represented by the black lines in Figure 31 and Figure 32. Even at the end of the overhead line the voltage would increase up to 1.2 p.u which is a clear violation of the given limit of +10% required by the EN50160. The maximum voltage at the furthest connection point in the grid (Weissensteinstrasse 14) would be even bigger. In addition, the overhead line would reach a loading of about 170% and thus could not be operated any longer. In this scenario, a central storage has proven to be a good solution. In this case, the peak PV power can be stored during the day, which prevents the voltage and the loading of the overhead line from reaching critical values. If, in the evening, the storage is fully charged with 1068 kWh, a discharge power of 89 kW is necessary in order to completely discharge the stored energy, in the given period from 8 pm to 8 am. The discharge power of 89 kW would cause an increase of the voltage up to 1.105 p.u at the end of the overhead line, which is still slightly in violation of the given limit of +10%. Therefore, it would be recommended to further decrease the discharge power. However, the loading of the overhead line is in an acceptable range with 80%.

In conclusion, up to a certain point, the PV growth predicted by the «Energiestrategie 2050» can be managed with help of a central-storage system and an EMS. In this particular case however, it would still be advisable to reinforce the main supply line, i.e. the overhead line, in order keep the voltage in an acceptable range.

The correct dimensioning of a central storage system poses a challenge. On the one hand, the storage must be big enough to store the whole PV power during the day. On the other hand, the storage must be completely discharged during the night with a discharge power that will not cause any overvoltage or overloading of the lines. In this scenario, the discharge time was 12 h, which is possible since the PV profiles are based on a measurement made in the fall. However, in the summer, the period when the storage can be discharged is much smaller, since the days and the times when the PV systems are productive, is longer. This would require a larger discharge power of the central storage to feed all of the stored energy back into the grid. However, in this case, this is not possible since the discharge power of 89 kW already is causing a slight violation of the voltage limit at the connection point. A possible solution would be to increase the power-dead-band at which the EMS starts to charge the storage to keep the total stored energy during one day below 1086 kWh. As an Example: If the sun sets at 9 pm and rises at 6 am the time when the storage can be discharged is 9h. However, the maximal allowed discharge power is approximately 89 kW. This leads to a maximum-allowed state of charge for the storage system of 75%:

$$\text{max. SOC of storage in summer} = \frac{\text{max. discharge power} * \text{discharge time}}{\text{storage capacity}} = \frac{89 \text{ kW} * 9 \text{ h}}{1068 \text{ kWh}} = 0.75$$

This means that the maximum allowed SOC, as well as the time when the storage is being discharged, must be adjusted, depending on the season and on the length of the day.

9 RQ-3006: Impact of the decentralized energy production on the power quality

Based on measurements in the Prosumer-Lab the influences of an inverter on the power quality at its connection is investigated.

9.1 Summary

Due to its power electronics, an inverter always distorts the voltage at its connection point, to a certain degree, when feeding in. The degree of that distortion generally depends on the short circuit power, respectively the grid impedance, at the connection point. In general, inverters connected to a grid with a low short-circuit power cause more distortion of the voltage. Three power-quality measurement devices were installed inside the Prosumer-Lab to measure the influence of the inverter on the harmonics. It could be shown, that the inverter causes an increase of the voltage harmonics. However, this is the case only when the Prosumer-Lab is connected directly to the local grid. If the Prosumer-Lab is supplied via the grid emulator, the behavior of the harmonics is unusual, since the grid-emulator does not always represent the behavior of a real grid.

9.2 Method

Figure 34 shows a schematic representation of the measurement set up in the Prosumer-Lab. A total of three PQ-Boxes, manufactured by “a-eberle”, were used to measure the power quality at three different points in the Prosumer-Lab. One was installed right after the grid emulator, respectively at the connection to the house grid. The other two PQ-Boxes were installed at the connection point of the PV system and the storage system, respectively.

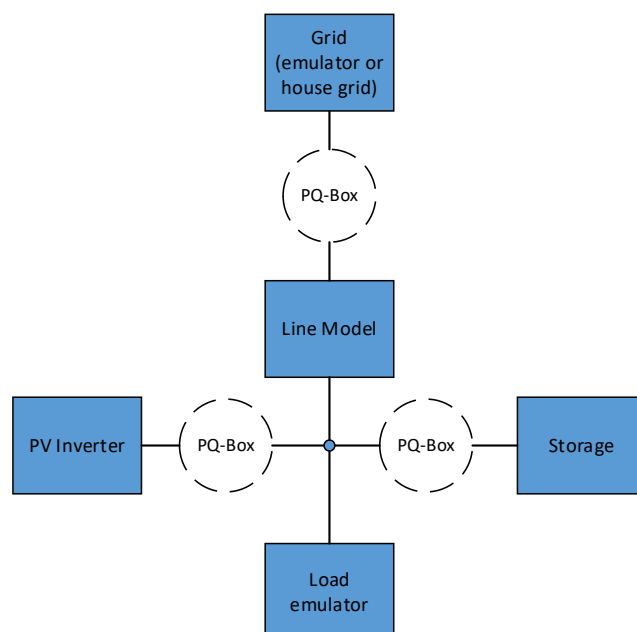

Figure 34: schematic representation of the measurement set up in the Prosumer-Lab

The complete line model consists of eight separate line segments. Each segment represents a cable of a certain length and cross section. The model allows us to reproduce the following lines:

- 16 mm², 50 m to 200 m
- 50 mm², 75 m and 150 m
- 150 mm², 100 m and 200 m

Figure 35 shows the current driven by the load emulator and the current fed in by the inverter of the PV system during the measured scenario. The same scenario was run several times with the Prosumer-

Lab under different configurations of the line model, as well as the power supply (grid emulator or house grid).

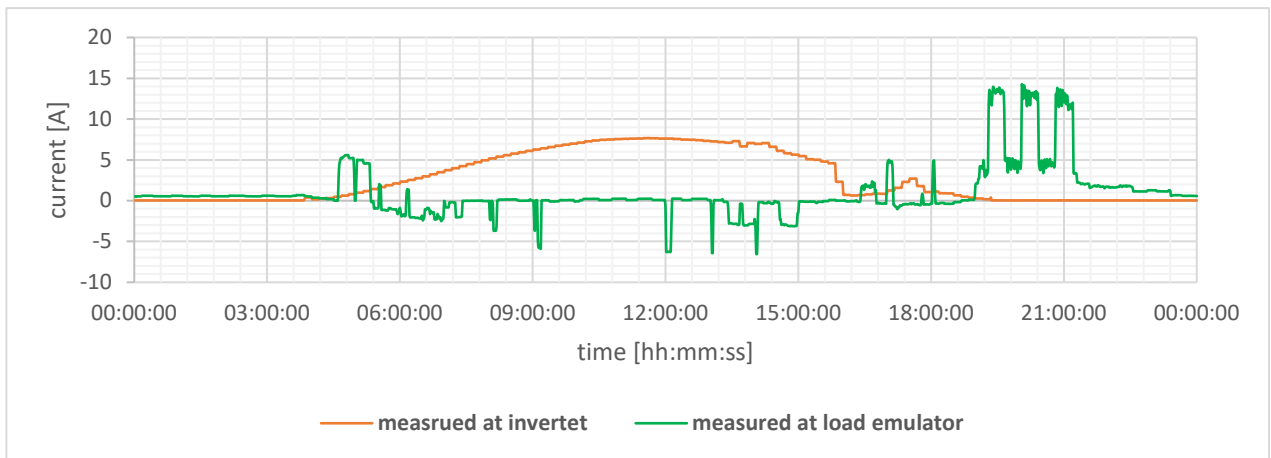

Figure 35: current measured at the load emulator the inverter during the scenario.

9.3 Results

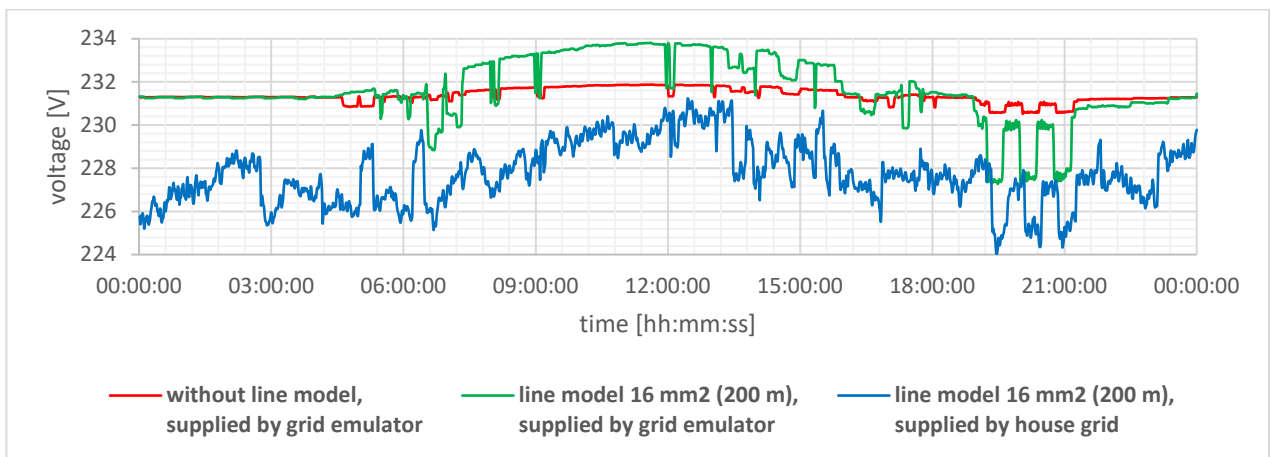

Figure 36: voltage measured after the line model

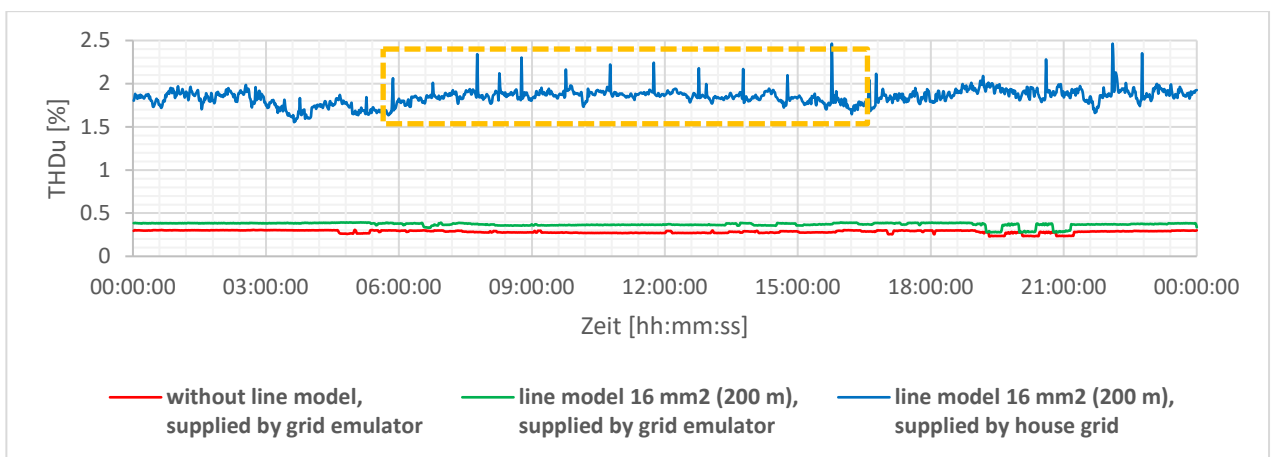

Figure 37: total harmonic distortion measured after the line model

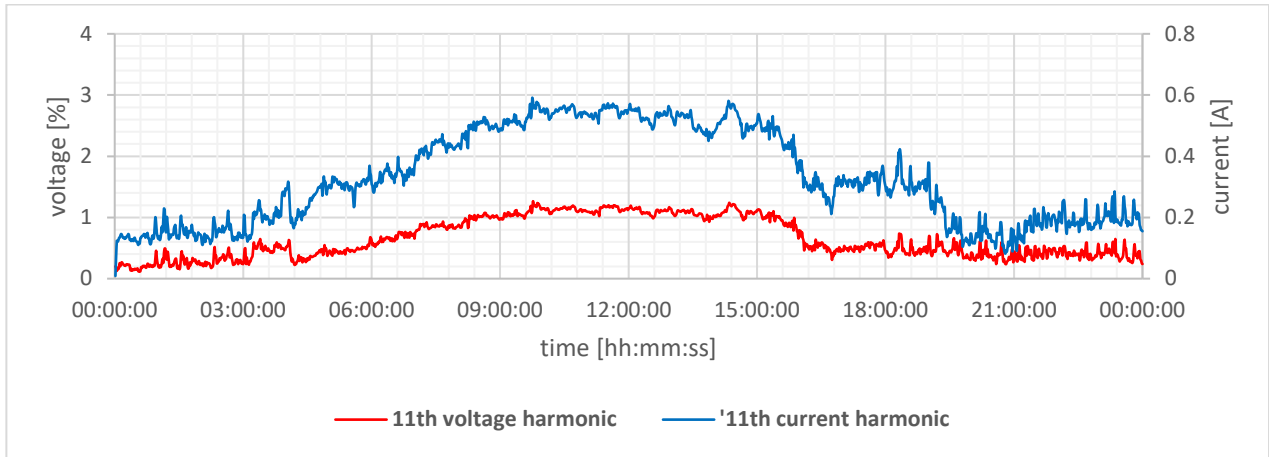

Figure 38: voltage and current harmonic of the 11th order, measured after the line model while the Prosumer-Lab was supplied by the house grid

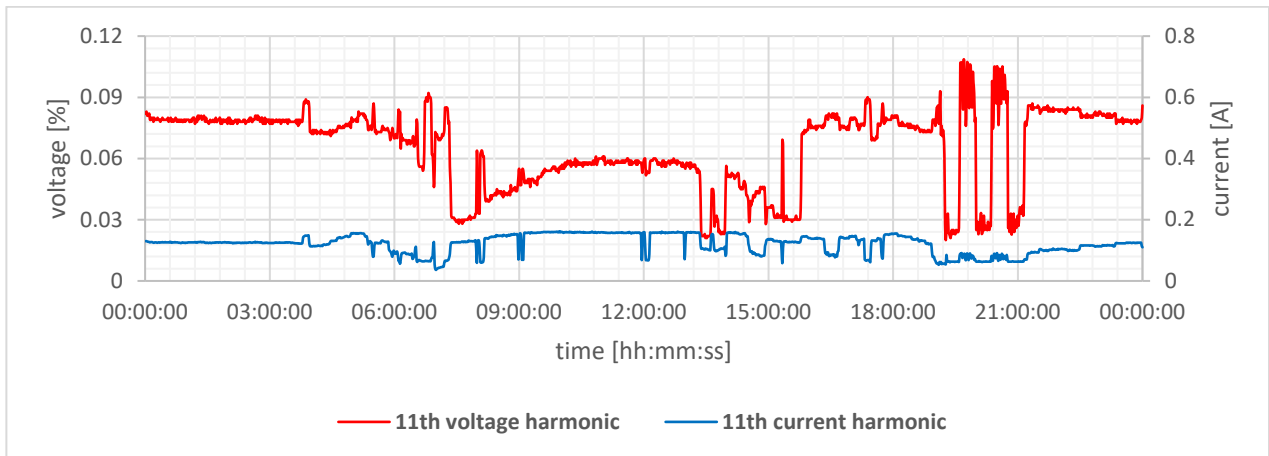

Figure 39: voltage and current harmonic of the 11th order, measured after the line model while the Prosumer-Lab was supplied the grid emulator

9.4 Discussion

Figure 36 shows the voltage values measured at the node right after the line model. For the case when the Prosumer-Lab is connected to the grid emulator, the voltage increases by approximately 2.51 V (green curve). Considering the maximum current of 7.58 A fed in by the PV-system (Figure 35), according to Ohm's law, this results in a impedance of 0.33 Ω for the line model. With the specific resistance of a copper wire of 1.8 E-8 Ωm for a 16mm² line of 200 m length and an inductivity of 0.3 μH , the following theoretical impedance is obtained:

$$|Z|_{\text{theoretical}} = \frac{\rho_{\text{Cu}} * l}{A} + L * 2\pi f * l * j = \frac{1.8 * 10^{-8} \Omega\text{m} * 200 \text{ m}}{16 \text{ mm}^2} + 0.3 \mu\text{H} * 2\pi * 50 \text{ Hz} * 200 \text{ m} * j = 0.23 \Omega$$

Considering the contact resistance and the resistance of the connecting cables, an impedance of 0.33 Ω for the line and thus a resulting voltage increase of 2.51 V is plausible. In the case when the Prosumer-Lab is connected directly to the local grid, the voltage increase due to the additional line resistance from the transformer station to the Prosumer-Lab is around 5 V (blue curve).

Figure 37 shows the THD_v (total harmonic distortion) measured at the end of the line model. The THD_v is about 0.1% larger if the line model is integrated in the Prosumer-Lab (green curve). If the Prosumer-Lab is supplied via the local grid and not the grid emulator, the THD_v is considerably larger due to the voltage harmonics that are already present in the grid. However, the influence of the inverter can be seen, in the form of a slight increase of the THD_v during the day (orange mark).

Figure 38 shows the 11th voltage and current harmonics measured at the end of the line model, while the Prosumer-Lab is supplied directly by the house grid. The line model represents a 16 mm²-line of 200 m length. One recognizes an increase of the harmonic current of approximately 0.5 A, which causes the corresponding increase of the harmonic voltage. The 15th harmonic behaves identically to the 11th. However, the 5th and the 7th harmonics show an inverse behavior. The harmonic voltage drops during the day and increases in the evening. The chart of the other harmonics can be found in the appendix 15.4

Figure 39 also shows the 11th harmonics measured at the end of the line model. However, in this case, the Prosumer-Lab is supplied via the grid emulator instead of the local grid. The harmonic current now is between 0.05 A and 0.15 A which is significantly smaller than before. There are two possible reasons for this observation. One might be that the current control algorithm of the inverter uses the measured voltage at the connection point as input. The inverter then feeds the current, based on the measured voltage. If this voltage represents a perfect sine wave, then the current fed by the inverter will not contain any harmonics. On the other hand, if the voltage is already distorted to a certain degree, as is usually the case in the low-voltage grid, the inverter will adjust the current according to this voltage and will also feed harmonic currents. Another possible reason might be that, since the grid emulator decouples the Prosumer-Lab grid from the local grid, the harmonic currents caused by the inverter are being suppressed. In this case, the grid emulator would not behave like a real grid.

10 Conclusion

Two types of EMSs have been investigated. On the one hand, the power-controlled EMS, which sets the charging or discharging power of the battery storage system according to the power flow at the main connection point of the house. And on the other hand, the voltage-controlled EMS, which sets the charging or discharging power of the battery storage system based on the voltage measured at the connection point. Considering the power-controlled EMS, simulations have shown that in order to maintain or even improve the grid stability, it is crucial that either the storage is dimensioned big enough (at least 1 kWh capacity for each kW_p PV power), or the power dead-band limit at which the EMS starts to charge the battery is high enough (at least 50 % of the nominal PV power). It could be shown that, when all the prosumers have a PV and storage system, and the dead band is too low (± 1 kW), the storages are not capable of storing the peak in PV power, leading to a sudden voltage increase in the afternoon. In this scenario, it is assumed that the PV- and storage systems are dimensioned according to the common rule of thumb (1 MWh consumption per year = 1 kW nominal PV power = 1 kWh storage capacity). Therefore, it is beneficial if the EMS adapts the dead band according to the weather forecast, meaning that when a sunny day is predicted, the dead band should be increased. It could also be shown, that with a dead band of 50% of the PV nominal power, the power peak at the early afternoon, can be stored entirely, which prevents an increase of the voltage that is too high.

Concerning the voltage-controlled EMS, the simulations have shown that to get a satisfying result, the EMS needs to be parametrized correctly. Otherwise oscillations of the storage power and thus in the voltage can occur. It could be shown that in case of the investigated grid in Schüpfenried, the voltage rise during the day can be damped up to 3% with voltage-controlled EMSs.

To conclude, in terms of grid stabilization the power-controlled EMS seems to be more effective than the voltage-controlled EMS, but only for cases in which a bigger dead band is defined. The EMS with the dead band of 1 kW will not decrease the voltage for the whole day, which will lead to a strong increase of the voltage in the afternoon. From the point of view of the DSO, this configuration is therefore not desirable.

To answer the focus question: in order to guarantee or even improve grid stability, an EMS must fulfill the following conditions:

- Dead band (i.e. threshold) at which the EMS starts to charge the storage must be set high enough (at least 50% of the nominal PV power) to store the peak of PV power.
- Storage must be dimensioned large enough (at least 1 kWh capacity for each kW_p PV power).
- Regarding the voltage-controlled EMS: A correct parameterization in terms of the droop value is crucial in order to avoid oscillations.

Furthermore, the impact on grid stability in case of a malfunctioning EMS has been investigated. It was assumed that due to a malfunction of the EMS, all storage systems in the grid were being charged simultaneously during the evening with nominal charging power. As the simulation has shown, this scenario would lead to a decrease of the lowest terminal voltage in the grid down to 0.79 p.u, which is clearly below the given limit of -15%. The loading of the overhead line would reach 95% in this particular scenario and would therefore still be operable.

Moreover, the growth of PV systems according to the «Energierstrategie 2050» has been investigated. The «Energierstrategie 2050» projects a total of 11'036 GWh energy produced by photovoltaic systems. This leads to a total of 44.8% of the available roof space of every house in Switzerland, which needs to be covered by a PV-system. In the analyzed grid, many of the houses are farmhouses with very large roofs. Simulations have shown that in such cases, an EMS and storage system for every single house would be unnecessary, since the consumption of the house is very small, compared to the resulting production. A possible alternative solution would be a central storage with an EMS somewhere in the low voltage grid, e.g. next to the transformer station or, as in the case considered, at the end of the main supply line. It could be shown that, up to a certain point, the PV growth projected by the «Energierstrategie 2050» can be managed by the grid with the help of a central storage system. In this particular case however, it would still be advisable to reinforce the main supply line, i.e. the overhead line, in order keep the voltage in an acceptable range.

11 Outlook

The EMSs could be a useful tool for the DSO in the future to manage grid instabilities, which are occurring due to the continuous increase in the number of prosumers. The simulations done in this project revealed that there is a clear potential for an EMS to help and even improve the stability of the grid. However, it is important to mention that these simulations are based on synthetic load profiles applied to the customers in the specific grid of Schüpfenried. The effect of an EMS on the grid stability however can change, depending on the grid topology, as well as the load profiles of the customers in the grid. It is therefore strongly recommended that before the DSO relies on EMSs as a solution to maintain or improve grid stability, a simulation for that particular grid should be carried out.

Finally, the simulations regarding the voltage-controlled EMSs showed the problems which could arise when the EMS's parameters are set incorrectly. The results of this simulation laid the groundwork for this subject. However, further investigations regarding a proper and practical parametrization to prevent oscillation are required. Furthermore, it is also recommended to consider a dynamic simulation in order to properly analyze the behavior of the voltage-controlled EMS.

12 List of Figures

Figure 1: Envelope of the voltages of all simulated grid points when all the EMSs are operating in power-controlled mode	5
Figure 2: Envelope of the voltages of all simulated grid points when all the EMSs are operating in voltage-controlled mode	5
Figure 3: Change of voltage in percent between the reference scenario and the various configuration of the EMS	6
Figure 4: Power flow in the overhead line when all the EMS are operating either in voltage-controlled mode or in power-controlled mode	7
Figure 5: Research fields dealt with in this report are highlighted in orange, inputs from research questions in other subject areas are highlighted in blue	9
Figure 6: Scheme of the analyzed part of the low voltage grid of Schüpfenried	10
Figure 7: Rule of thumb for the dimensioning of the PV and battery storage systems	11
Figure 8: Data of the storage «LG Chem»	11
Figure 9: Size of the PV and storages systems	11
Figure 10: Schematic representation of the EMS model	12
Figure 11: Envelope of the voltages of all simulated grid points	13
Figure 12: Envelope of the voltages of all simulated grid points	13
Figure 13: Size of the PV and storage systems and the definition of the upper dead band in order to charge the storage	15
Figure 14: Envelope of the voltages of all simulated grid points	15
Figure 15: Loadings of the overhead line	16
Figure 16: Relation between change in voltage and the resulting storage power set by the EMS for different droop values	17
Figure 17: Envelope of the simulated voltages at all connection points as well as the loading of the overhead line when the EMS are operating in voltage-controlled mode without any droop value assigned (respectively with a droop value of ∞)	18
Figure 18: Envelope of the simulated voltages at all connection points when all the EMS are operating in voltage-controlled mode with a droop value of 25 W/V	18
Figure 19: Loading of the overhead line when all the EMS are operating in voltage-controlled mode with a droop value of 25 V/W	19
Figure 20: Power flow in the overhead line when all the EMS are operating either in voltage-controlled mode or in power-controlled mode	19
Figure 21: Process of parameterizing a voltage-controlled EMS	20
Figure 22: change of voltage in percent between the reference scenario and the various configurations of the EMSs	23
Figure 23: Change of the line loading in percent between the reference scenario and the various configuration of the EMSs	23
Figure 24: simulated voltage at Weissensteinstrasse 14 as well as the loading of the overhead line, depending on the number of malfunctioning EMS	25
Figure 25: voltage at the terminal of the Weissensteinstrasse 14 when there is a malfunction of all the EMS in the grid	26
Figure 26: loading of the overhead line when there is a malfunction of all the EMS in the grid	26
Figure 27: energy production with PV systems according to the «Energierstrategie 2050» [3]	27
Figure 28: intersection of several potentials in terms roof space suitable for PV systems	27
Figure 29: advantages and disadvantages of the central storage with EMS compared to an EMS and a storage system for every single house	28
Figure 30: Scheme of the analyzed part of the power grid with a central EMS and storage system. Next to each load the roof size and nominal PV power is given	29

Figure 31: voltage at the connection point of the central storage	30
Figure 32: loading of the overhead line	30
Figure 33: state of charge of the central storage	30
Figure 34: schematic representation of the measurement set up in the Prosumer-Lab	32
Figure 35: current measured at the load emulator the inverter during the scenario.	33
Figure 36: voltage measured after the line model	33
Figure 37: total harmonic distortion measured after the line model	33
Figure 38: voltage and current harmonic of the 11 th order, measured after the line model while the Prosumer-Lab was supplied by the house grid	34
Figure 39: voltage and current harmonic of the 11 th order, measured after the line model while the Prosumer-Lab was supplied the grid emulator	34
Figure 40: parameter of the EMS and storage system	41
Figure 41: condition at which the storage is being either charged or discharged	41
Figure 42: Schematic representation of the EMS model with signals marked in blue	42
Figure 43: EMS in power-controlled mode with a dead band of ± 1 kW	42
Figure 44: EMS in voltage-controlled mode with no droop value assigned	43
Figure 45: relation between change in voltage and the resulting storage power for different droop values	44
Figure 46: EMS in voltage-controlled mode with a droop value of 75 assigned	44
Figure 47: EMS in voltage-controlled mode with a droop vale of 75 compared to a droop value of 100	44
Figure 48: measured power profile of the PV and the load emulator in the Prosumer-Lab	45
Figure 49 simulated and measured operation power of the storage	45
Figure 50: Load profiles generated by the loaf profile generator of Noah Pflugradt used for the simulation	46
Figure 51: PV profiles based on a measurement in Thun from October 2018 used for the simulation	46
Figure 52: harmonic voltages measured after the line model while the Prosumer-Lab was supplied by the house grid and not the grid emulator	47
Figure 53: harmonic currents measured after the line model while the Prosumer-Lab was supplied by the house grid and not the grid emulator	47

13 Glossary

Abbreviation	Description
BEM	Business Ecosystem Management (BFH-TI)
BFE / SFOE	Bundesamt für Energie
BKW	BKW Energie AG
CSEM	Centre Suisse d'Electronique et de Microtechnique
DSO	Distribution system operator
EMS	Energy Management System
LBS	Labor für Batterien und Speichersysteme (Speichergruppe, BHF-TI)
LEN	Labor für Elektrizitätsnetze (Netzgruppe, BFH-TI)
LPV	Labor für Photovoltaiksysteme (PV-Labor, BFH-TI)
TS	Transformator station
p.u	Per unit
PV	Photovoltaic

14 References

- [1] N. Pflugradt, "loadprofilegenerator.de," [Online]. Available: <https://loadprofilegenerator.de/>.
- [2] Meteotest, "Berechnung der Energiepotenziale für Wind- und Sonnenernergie," 28 September 2012. [Online]. Available: <https://www.bafu.admin.ch>. [Accessed 07 May 2018].
- [3] BFE - Bundesamt für Energie, "Energiestrategie 2050," 18 01 2018. [Online]. Available: <http://www.bfe.admin.ch/energiestrategie2050/index.html>. [Accessed 20 02 2018].
- [4] Meteotest, "Solarpotenzial Schweiz," 13 Januar 2017. [Online]. Available: www.meteotest.ch. [Accessed 22 May 2018].

15 Appendix

15.1 EMS model

Using the power-system analysis software PowerFactory from DigSILENT, a quasi-dynamic simulation model (QDSL model) of an energy manager (EMS) has been implemented. The QDSL model of the EMS provides an abstracted form of a real EMS and is used for qualitative analysis of different grid situations. The model of the EMS as well as the storage system requires several parameters as shown in Figure 40.

parameter	Unit	description
SOC	%	State of charge of the storage
Eini	MWh	Max. capacity of the storage
SOCini	%	Initial state of charge
SOCmin	%	Minimal state of charge
SOCmax	%	Maximal state of charge
Pcharge	MW	Nominal power to charge/discharge the storage
PStartStore	MW	Power, measured at the connection point of house, at which the storage is being charged (upper dead band)
PStartFeed	MW	Power, measured at the connection point of house, at which the storage is being discharged (lower dead band)
umax	p.u	max. terminal voltage
umin	p.u	min. terminal voltage
droop	-	Droop for voltage-controlled mode

Figure 40: parameter of the EMS and storage system

The EMS gets information about the power flow at the connection point of the house (P_{Line}) as well as the power at which the storage is being operated (P_{batt}). According to Kirchoff's law, this can be expressed as follows:

$$P_{meas} = P_{PV} - P_{Load} = P_{Line} - P_{batt}$$

The model of the EMS assumes that if P_{meas} ³ is positive, power is fed into the grid and if P_{meas} is negative, power is taken from the grid. Furthermore, the EMS receives information about the voltage at the connection point of the house (u_{term}). As soon as P_{meas} or u_{term} is outside the dead band defined by the parameters in Figure 40, the storage is charged or discharged. In Figure 41, the charging and discharging conditions of the storage are summarized.

condition	Operation of storage
[$P_{meas} < -P_{StartFeed}$] OR [$u_{term} \leq u_{min}$]	discharge
[$P_{meas} < P_{StartStore}$] OR [$u_{term} \leq u_{max}$]	charge

Figure 41: condition at which the storage is being either charged or discharged

Figure 42 shows a Schematic representation of the described EMS model.

³ P_{meas} represents the difference of the simulated PV power and the load

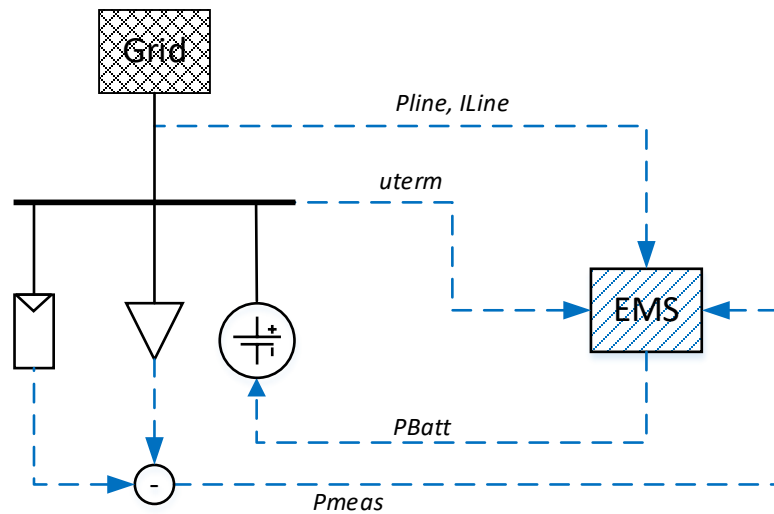

Figure 42: Schematic representation of the EMS model with signals marked in blue

15.1.1 Power-controlled EMS EMS

Figure 43 shows the simulated charging and discharging power, which is set by the EMS according to the load and PV profiles. In this case, the EMS operates in the power-controlled mode, which means the charging or discharging power of the battery is defined by the difference in the power of the PV system and the load (P_{meas}). If this value exceeds the dead band of ± 1 kW, the storage is charged or discharged. The charging or discharging power corresponds to the difference between the power of the PV system and the load, provided this value does not exceed the nominal capacity of the storage system. Otherwise, the storage is operated at rated power.

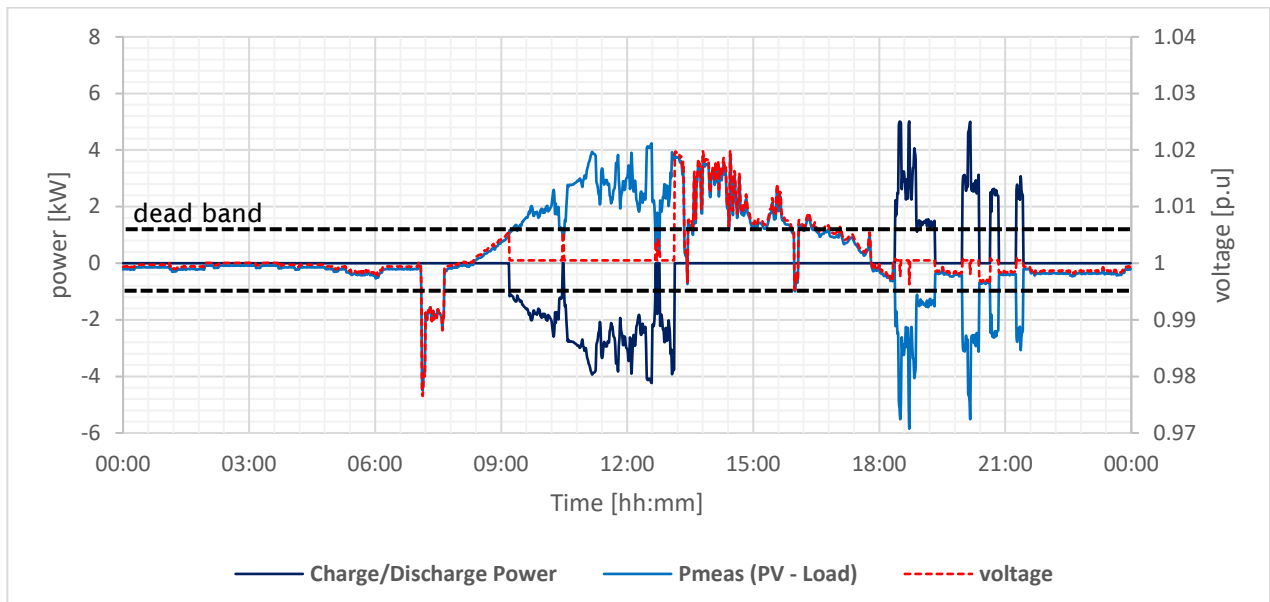

Figure 43: EMS in power-controlled mode with a dead band of ± 1 kW

15.1.2 Voltage controlled EMS without droop

Figure 44 shows the same situation when the EMS defines the charge or discharge power of the battery based on the voltage at the connection point. If the voltage rises above 1.02 p.u, the storage is charged. If it drops below 0.99 p.u, the storage will be discharged. The power at which the storage is being operated corresponds to P_{meas} , provided this value does not exceed the rated power of the storage. Otherwise, the storage is operated at rated power.

It can be clearly seen that every time the dead-band limit is violated, the EMS adjusts the charge or discharge power of the storage and thereby influences the voltage in the next simulation step. This leads to an oscillating behavior of the EMS and consequently also the voltage. The voltage-controlled operating mode of the EMS without any droop value assigned is therefore not suitable.

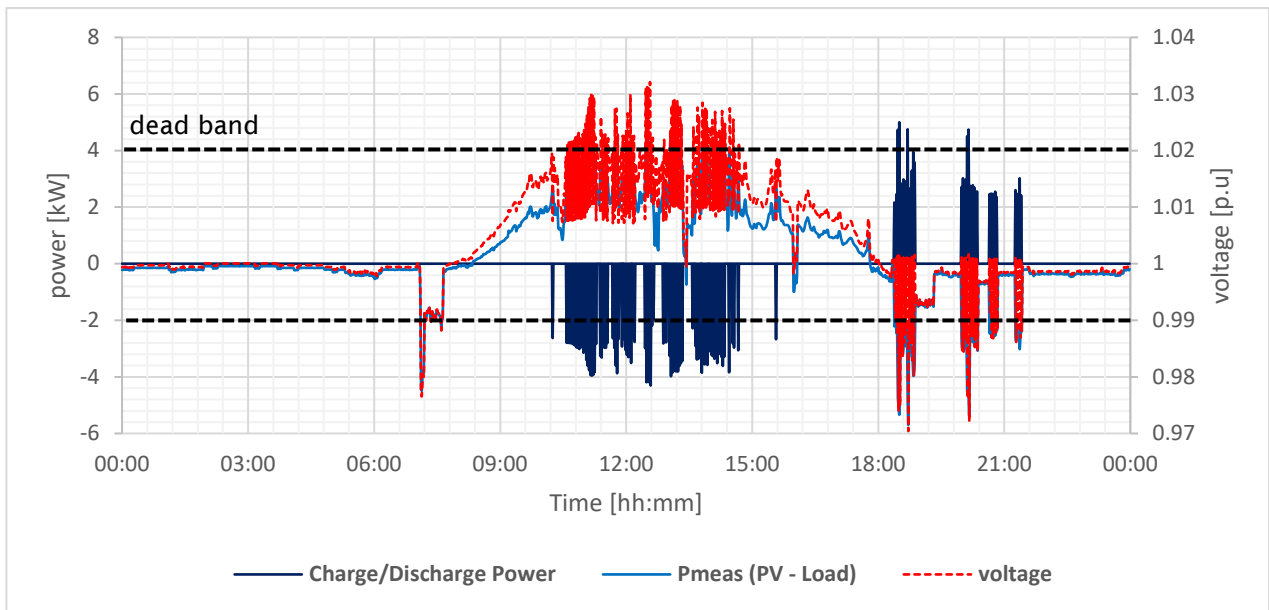

Figure 44: EMS in voltage-controlled mode with no droop value assigned

15.1.3 Voltage controlled EMS with droop

To get a stable operation of the EMS in voltage-controlled mode, the EMS must have a droop assigned. The droop determines how sensitive the EMS sets the storage power depending on a specific voltage change. With a very high droop, the storage power is set very high even when the changes in the voltage are very small, which may result in an oscillating behavior. An infinitely large droop results in the behavior of the voltage as it is shown in Figure 44. On the other hand, with a droop value of zero, the EMS shows no response to a change in voltage. The storage power remains independent of the voltage at 0 p.u. Figure 45 shows the storage power as a function of the voltage at its connection point for different droop values. Within the dead band of $\pm 2\%$ of the rated voltage, the storage power remains at 0 p.u. Since the voltage in the grid is never quite constant, this dead band is essential to prevent unnecessary charging or discharging of the storage and thus maximizing its lifetime. Outside the dead band, the straight line has a slope of 25, this value corresponds to the droop value. With a droop value of 25, the storage is operated at rated power as soon as the voltage changes about $\pm 6\%$.

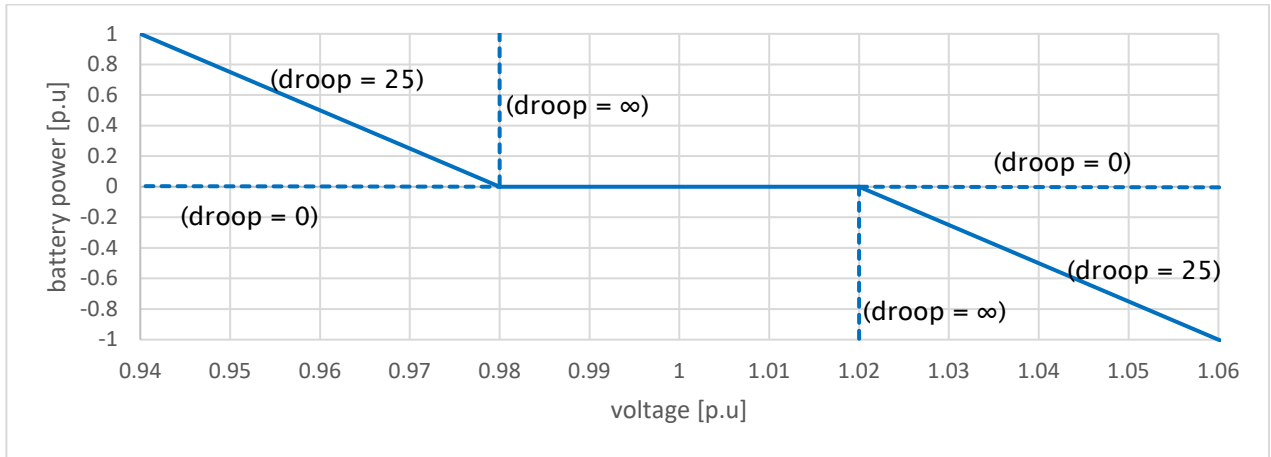

Figure 45: relation between change in voltage and the resulting storage power for different droop values

Figure 46 shows the voltage at the connection point as well as the charging or discharging power of the storage when the EMS has a droop value of 75 assigned. If the voltage rises above 1.02 p.u., the storage is charged. On the other hand, if the voltage drops below 0.99 p.u., the storage will be discharged.

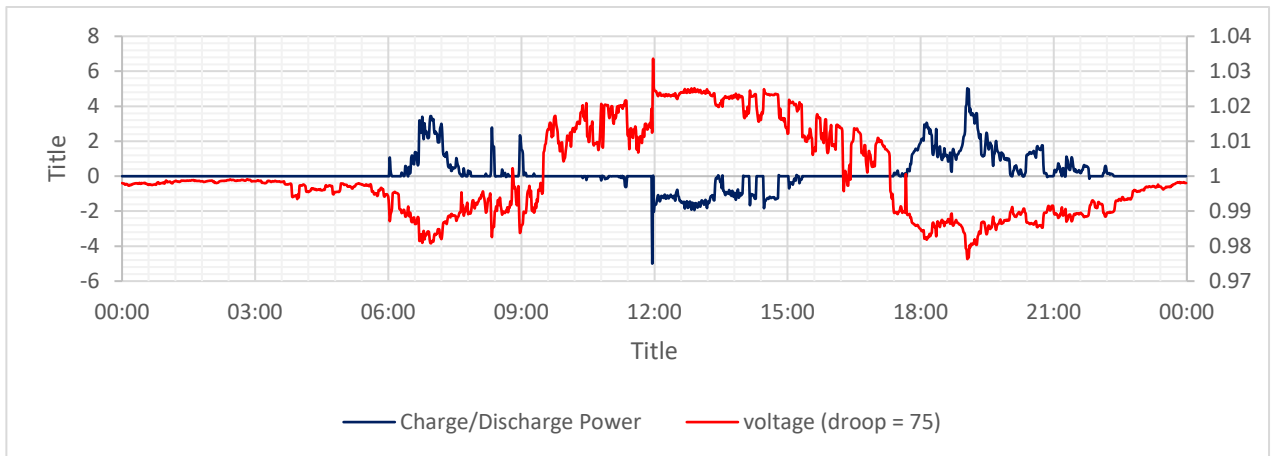

Figure 46: EMS in voltage-controlled mode with a droop value of 75 assigned

When the EMS is operated in the same situation with a droop value of 100, the operation power of the storage is adapted in a too sensitive way on a given change in the voltage. Thus, the system starts to oscillate (Figure 47).

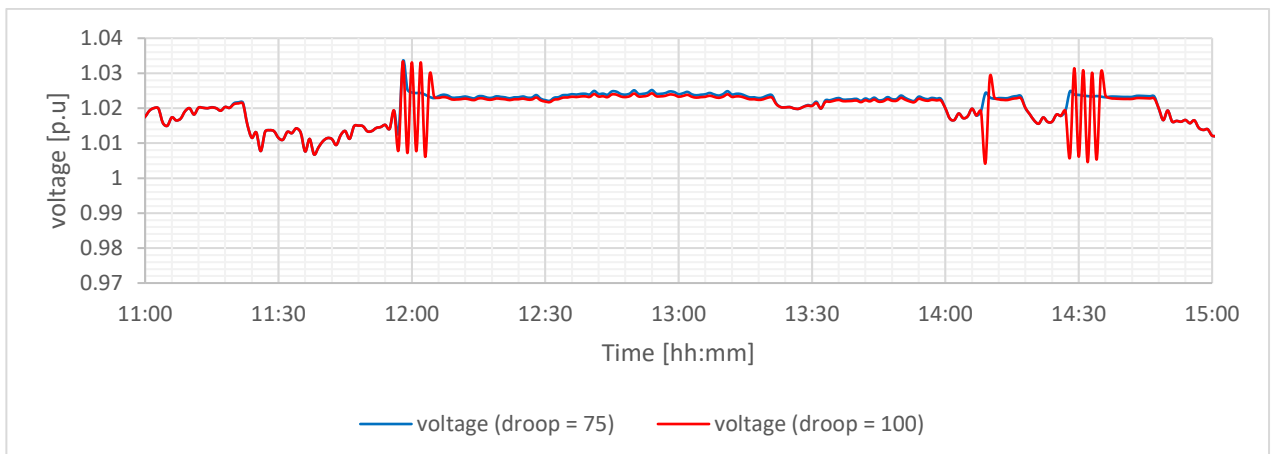

Figure 47: EMS in voltage-controlled mode with a droop value of 75 compared to a droop value of 100

15.2 Verification of the power-controlled EMS model

The implemented model of the EMS was verified using a Varta battery connected to the Prosumer-Lab. Like the EMS model in PowerFactory, the EMS of the Varta battery is also power-controlled. Figure 48 shows the load and PV profile measured in the Prosumer-Lab. Those profiles have been assigned to a PV system and a load in PowerFactory in order to verify the EMS model.

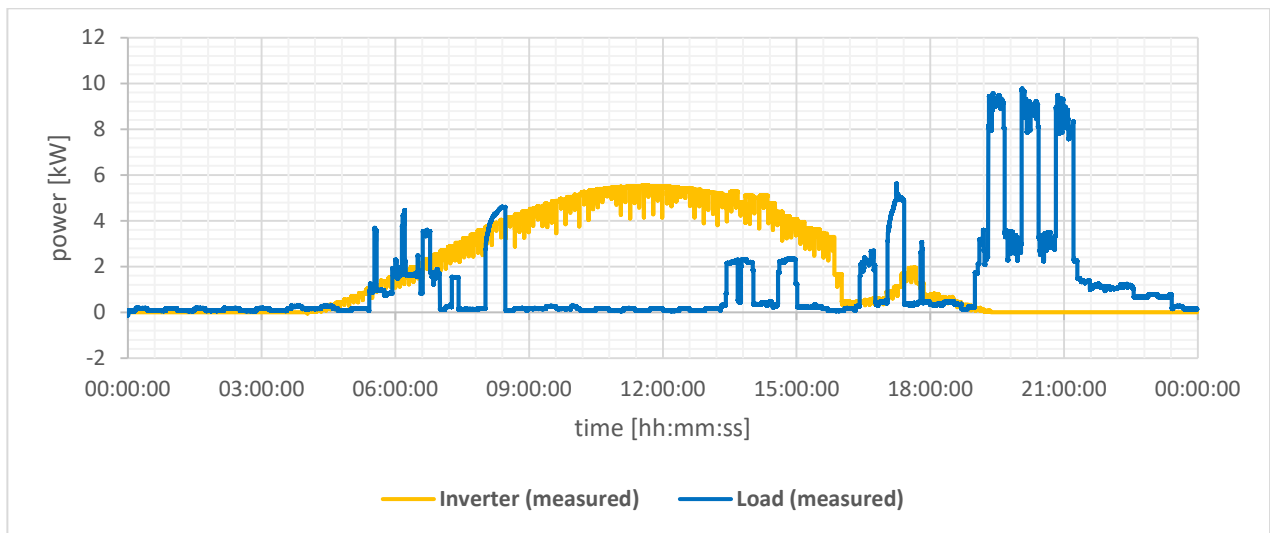

Figure 48: measured power profile of the PV and the load emulator in the Prosumer-Lab

Figure 49 shows the measured power profile of the Varta battery and the simulated power profile of the storage which results from the EMS model. The simulated power profile of the battery shows a difference of max. 10% to the measured one. The measured charging power exceeds the nominal power of 2 kW by approximately 200 W, whereas the measured discharge power is about 200 W smaller than the nominal power. Furthermore, around 10:00 where the storage has reached its full capacity, the charging power is not immediately reduced, but rather downshifted in the form of a ramp. This behavior is not considered in the EMS model. However, this is negligible for the simulations performed in this project. The EMS model is therefore of sufficient accuracy.

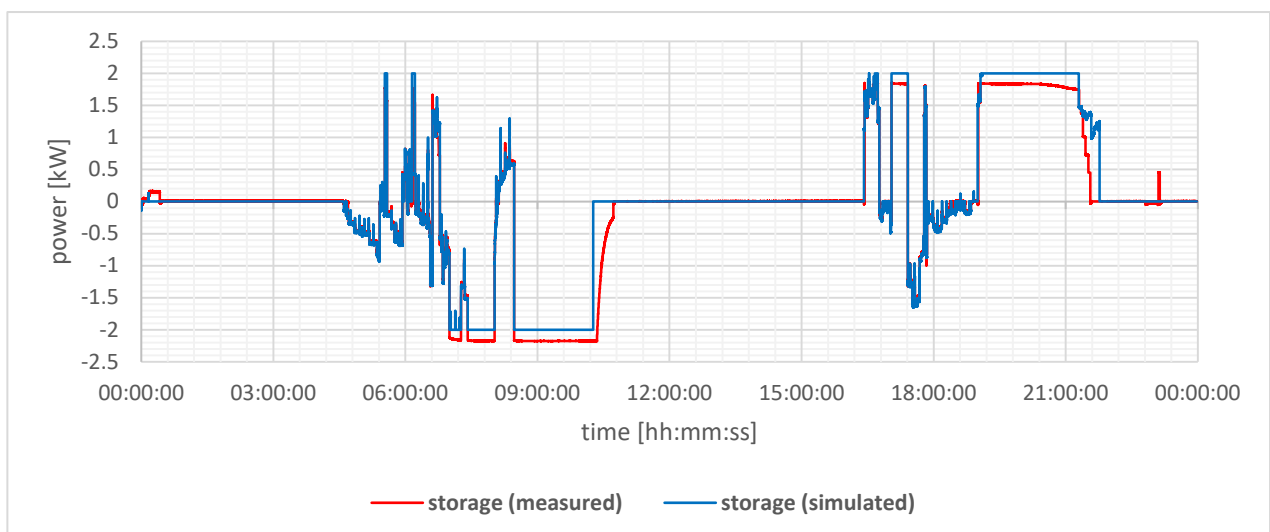

Figure 49 simulated and measured operation power of the storage

15.3 Load and PV profiles used for the simulation

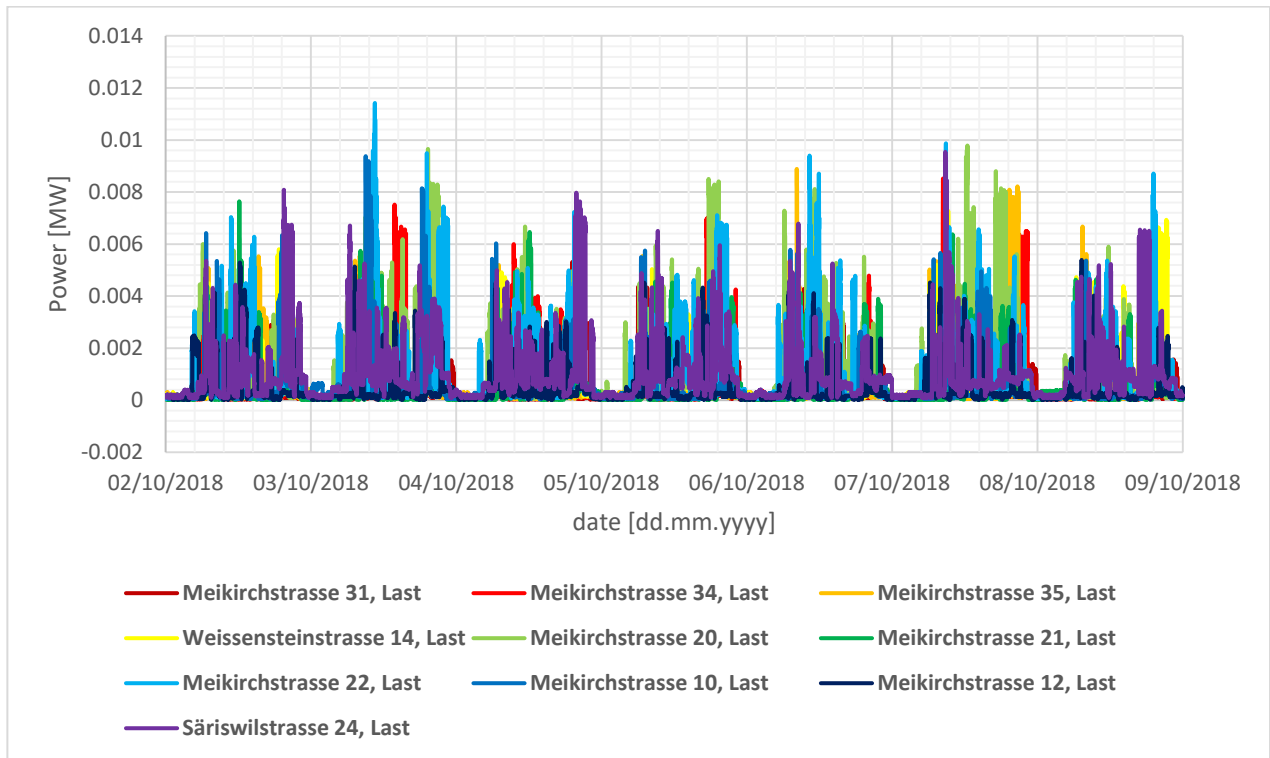

Figure 50: Load profiles generated by the load profile generator of Noah Pflugradt used for the simulation

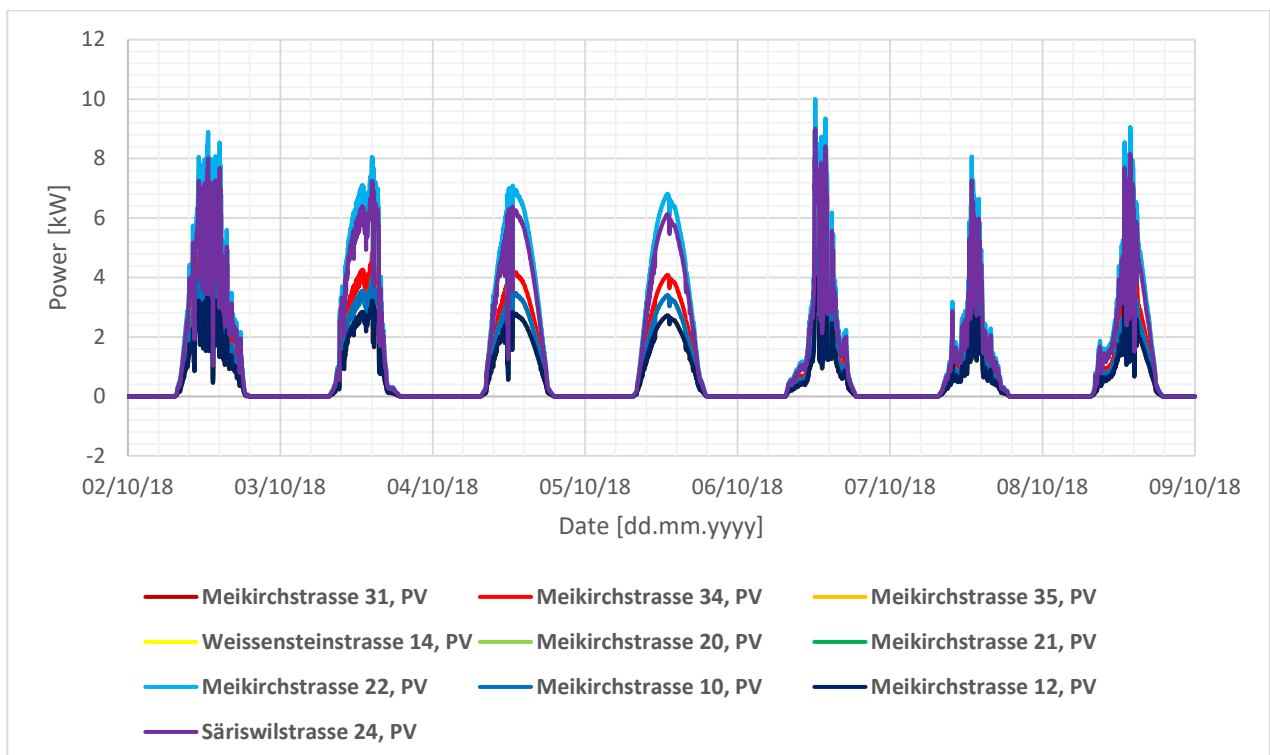

Figure 51: PV profiles based on a measurement in Thun from October 2018 used for the simulation

15.4 Harmonics measured in the Prosumer-Lab

Voltage and current harmonics measured at the end of the line model while the Prosumer-Lab is supplied direct by the house grid.

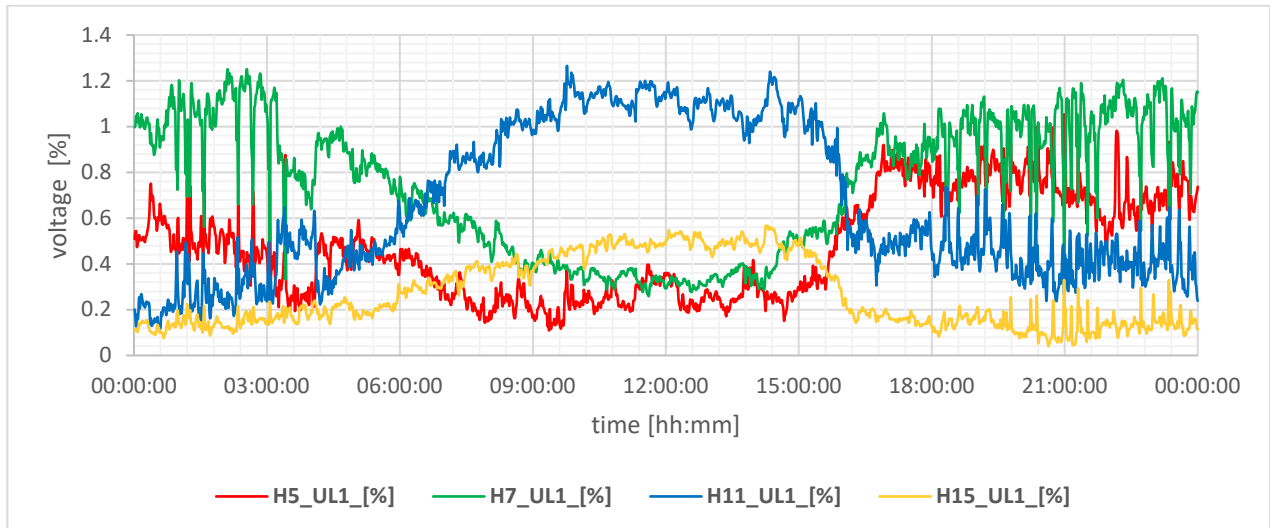

Figure 52: harmonic voltages measured after the line model while the Prosumer-Lab was supplied by the house grid and not the grid emulator

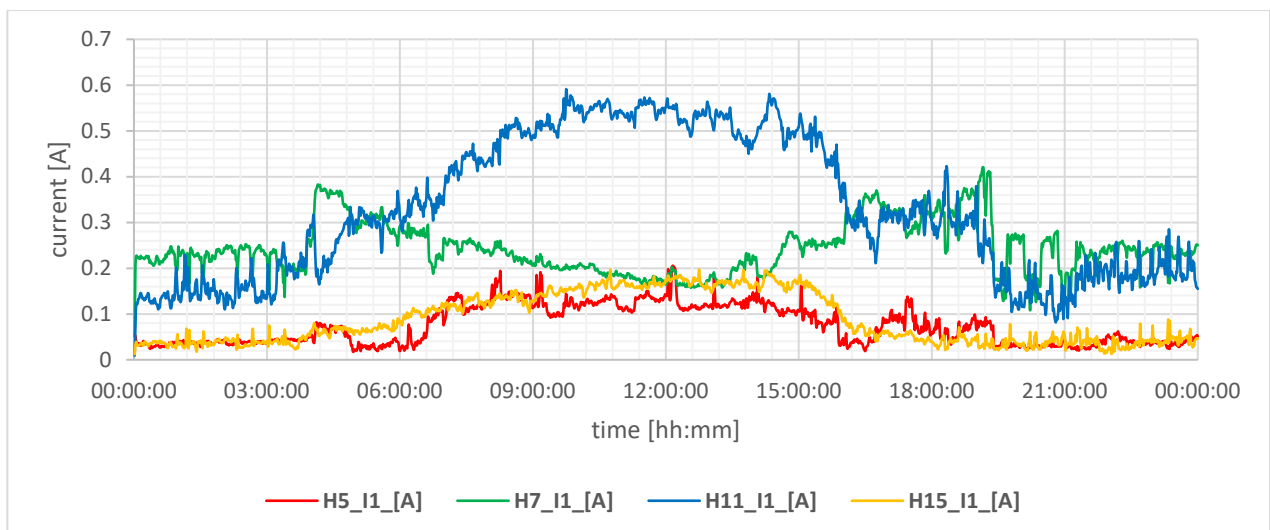

Figure 53: harmonic currents measured after the line model while the Prosumer-Lab was supplied by the house grid and not the grid emulator

16 Version control

Version	Date	Description	Author
0.1	15.04.2019	Template	Lukas Heiniger
0.7	18.06.2019	Overall documentation	Lukas Heiniger
0.8	26.06.2019	Correction	Michael Höckel, Lukas Heiniger
1.0	26.06.2019	release	Lukas Heiniger
1.1	16.07.2019	corrections	Lukas Heiniger
2.0	24.07.2019	Final release	Lukas Heiniger